



TLZ35

MICROPROCESSOR-BASED DIGITAL ELECTRONIC FREEZER CONTROLLER



OPERATING INSTRUCTIONS

Vr. 03 (ENG) - 18/02 - cod.: ISTR-MTLZ35ENG03

ASCON TECNOLOGIC S.r.l.

Viale Indipendenza 56, 27029 - VIGEVANO (PV) ITALY

Tel.: +39 0381 69871 - Fax: +39 0381 698730

<http://www.ascontecnologic.com>

info@ascontecnologic.com

PREFACE



This manual contains the information necessary for the product to be installed correctly and also instructions for its maintenance and use; we therefore recommend that the utmost attention is paid to the following instructions and to save it.

This document is the exclusive property of Ascon Tecnologic S.r.l. which forbids any reproduction and divulgation, even partially, of the document, unless expressly authorized.

Ascon Tecnologic S.r.l. reserves the right to make any formal or functional changes at any moment and without any notice.

Ascon Tecnologic S.r.l. and its legal representatives do not assume any responsibility for any damage to people, things or animals deriving from violation, wrong or improper use or in any case not in compliance with the instrument features.



Whenever a failure or a malfunction of the device may cause dangerous situations for persons, thing or animals, please remember that the plant has to be equipped with additional electromechanical devices which will guarantee safety.

Index

1. Instrument description	1
1.1 General description.....	1
1.2 Front panel description	2
2. Programming	2
2.1 Programming of the set point.....	2
2.2 Parameters programming	2
2.3 Parameter protection using a password.....	2
2.4 Parameters programming levels	2
2.5 ON/Stand-by Function	2
3. Usage warnings	3
3.1 Permitted use.....	3
4. Installation warnings	3
4.1 Mechanical mounting	3
4.2 Dimensions	3
4.3 Electrical connections	3
5. Functions	4
5.1 Measuring and visualization.....	4
5.2 Temperature control	4
5.3 Compressor protection function and power-on delay.....	4
5.4 Defrost control.....	4
5.5 Alarm functions	5
5.6 Digital input	5
5.7 Functioning of key U	5
6. Accessories	6
6.1 Parameters configuration by "A01".....	6
7. Programmable parameters table	7
8. Problems, maintenance and warranty	8
8.1 Notifications	8
8.2 Cleaning.....	8
8.3 Warranty and Repairs	8
8.4 Disposal	8
9. Technical data	8
9.1 Electrical characteristics	8
9.2 Mechanical characteristics.....	8
9.3 Functional features	9
10. Instrument ordering code	9

1. INSTRUMENT DESCRIPTION

1.1 General description

The **TLZ 35** is a microprocessor digital controller typically used in **cooling applications** with **ON/OFF temperature control** and **stop compressor defrost control** at pre-set time intervals.

The instrument has up to **2 relay outputs**, **1 PTC or NTC input for temperature probes** and **1 configurable digital input**.

The 2 outputs can be used to control the compressor or the temperature control device (**OUT**) and an alarm (**AL**).

The instrument is equipped with **4 program keys**, a **4-digit display** and **3 LED signals**, in addition to an **internal buzzer** that is the sound system for alarms.

Other important characteristics of the instrument are: program parameters protection using personalised password, switching on and off (stand-by) of the instrument using the **U** front key, parameters configuration via the **A01** device and the possibility to power the instrument with mains between 100 ... 240 VAC.

1.2 Front panel description

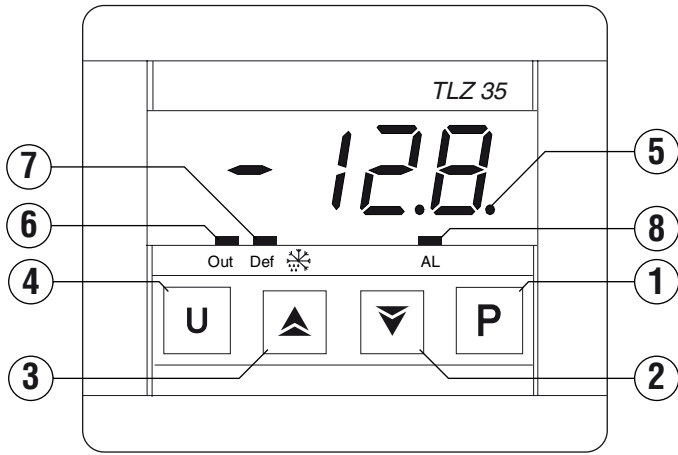

- 1 **P**: Used for setting the Set point and for programming the function parameters
- 2 **↓**: Used for decreasing the values to be set and for selecting the parameters.
- 3 **↑/☼**: Used for increasing the value to be set, for selecting the parameters and for activating manual defrosting.
- 4 **U**: It can be programmed via the parameter *U_{Srb}* to turning ON and OFF (stand-by) the device. In *hidden* parameter programming mode it is used to modify the visibility of the parameters (see paragraph 2.4).
- 5 **LED SET**: Indicates the input in programming mode and the programming level of the parameters. It also serves to indicate the Stand-by status.
- 6 **LED Out**: Indicates the compressor output (or the temperature control device) status: on (**ON**), off (**OFF**) or inhibited (**flashing**).
- 7 **LED DEF/☼**: Indicates defrosting in progress (**ON**) or dripping (**flashing**).
- 8 **LED AL**: Indicates the alarm status (**ON**), off (**OFF**) and silenced (**flashing**).

2. PROGRAMMING

2.1 Programming of the set point

Press the key **P** then release it, the display will show *SP* alternated with the Set Point value. To change it press the **↑** key to increase the value or **↓** to decrease it.

These keys increase or decrease the value one digit at a time, but if the button is pressed for more than one second the value increase or decreases rapidly, and after two seconds pressed, the speed increases even more to all the desired valued to be reached rapidly.

Exiting the Set mode is achieved by pressing the **P** key or automatically if no key is pressed for 15 seconds. After that time the display returns to the normal function mode.

2.2 Parameters programming

To access the instrument function parameters, press the key **P** and keep it pressed for about 5 seconds, after which the **LED SET** lights up and the display shows the code that identifies the first parameter.

Using the **↑** and **↓** keys, the desired parameter can be selected and pressing the **P** key, the display alternately shows the parameter code and its setting that can be changed with the **↑** and **↓** keys.

Once the desired value has been set, press the key **P** again: the new value will be stored and the display returns to show only the code of the selected parameter.

Pressing the **↑** and **↓** keys is now possible to another parameter and change it as described.

To exit the programming mode, press no keys for about 20 seconds, or keep the **↑** or **↓** key pressed until the instrument exits the programming mode.

2.3 Parameter protection using a password

The instrument has a parameter protection function using a password that can be personalised through the *PASS* parameter. To protect the parameters, set the desired password number in the parameter *PASS*.

When the protection is active, press the **P** key to access the parameters and keep it pressed for about 5 seconds, after which the **LED SET** starts flashing and the display shows *P*.

At this point, using the **↑** and **↓** keys, set the password number programmed and press the key **P**.

If the password is correct, the display shows the code that identifies the first parameter and it will be possible to program the instrument in the same ways described in the previous section.

Protection using a password can be disabled by setting the parameter *PASS* = **OFF**.

2.4 Parameters programming levels

The instrument has two parameter programming levels.

The first level (**visible** parameters) is accessed according to the procedure described above (with or without password request) while the second level (hidden parameters) can be accessed according to the following procedure:

- Remove the power supply to the instrument, press the key **P** and, keeping it pressed, power ON again the instrument;
- After about 5 s the **LED SET** lights up, the display shows the code that identifies the first parameter and will be possible to set the instrument parameters using the same programming procedure previously described.
- Once the parameter has been selected, if the **SET LED** is **ON**, it can be programmed even on the first (**visible**) level.
- If **SET** is **OFF**, the parameter can only be programmed on the **hidden level** (active now).
- To change the visibility of the parameter, press the **U** key: the **SET LED** changes its status indicating the accessibility level of the parameter (**ON** = **visible**; **OFF** = **hidden**).

The access procedure to *hidden* parameters is useful if the password set has been forgotten because allows to access the *PASS* parameter and check or change it.

2.5 ON/Stand-by Function

The instrument, once powered up, can assume 2 different conditions:

ON Means that the controller uses the control functions.

STAND-BY

Means that the controller does not use any control function and the display is turned off except for the green **LED SET**.

In case of power failure, the system always sets itself in the condition it was in before the black-out.

The ON/Stand-by function can be selected using the key **U** if the parameter *U_{Srb}* = **1** (see paragraph 5.7).

3. USAGE WARNINGS

3.1 Permitted use

 The instrument has been projected and manufactured as a measuring and control device to be used according to EN61010-1 for the altitudes operation until 2000 m.

The use of the instrument for applications not expressly permitted by the above mentioned rule must adopt all the necessary protective measures.

The instrument **MUST NOT BE USED** be used in dangerous environments (flammable or explosive) without adequate protection.

The installer must ensure that EMC rules are respected, also after the instrument installation, if necessary using proper filters.

 Whenever a failure or a malfunction of the device may cause dangerous situations for persons, thing or animals, please remember that the plant has to be equipped with additional devices which will guarantee safety.

4. INSTALLATION WARNINGS

4.1 Mechanical mounting

The instrument, in case 4 DIN Modules, is designed for mounting on DIN OMEGA rail.

Avoid placing the instrument in environments with very high humidity levels or dirt that may create condensation or introduction of conductive substances into the instrument.

Ensure adequate ventilation to the instrument and avoid installation in containers that house devices which may overheat or which may cause the instrument to function at a higher temperature than the one permitted and declared.

Connect the instrument as far away as possible from sources of electromagnetic disturbances such as motors, power relays, relays, solenoid valves, etc..

4.2 Dimensions

4.2.1 Mechanical dimensions

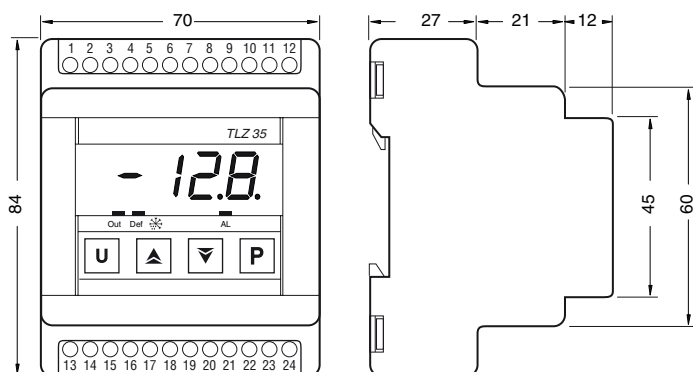

4.3 Electrical connections

Carry out the electrical wiring by connecting only one wire to each terminal, according to the following diagram, checking that the power supply is the same as that indicated on the instrument and that the load current absorption is no higher than the maximum electricity current permitted.

As the instrument is built-in equipment with permanent connection inside housing, it is not equipped with either switches or internal devices to protect against overload of current: the installation will include an overload protection and a two-phase circuit-breaker, placed as near as possible to the instrument, and located in a position that can easily be reached by the user and marked as instrument disconnecting device which interrupts the power supply to the equipment.

It is also recommended that the supply of all the electrical circuits connected to the instrument must be protect properly, using devices (ex. fuses) proportionate to the circulating currents. It is strongly recommended the usage of cables with proper insulation, according to the working voltages and temperatures.

Furthermore, the probe input cable must to be kept separate from line voltage wiring. If the probe input cable is shielded, the shield must be connected to the at only one side.

Whether the instrument is 12 V version it is recommended to use an external TCTR transformer, or with equivalent features, and to use only one transformer for each instrument because there is no insulation between supply and input.

 It is strongly recommended to check that the parameters are those desired and that the application functions correctly before connecting the outputs to the actuators so as to avoid malfunctioning that may cause irregularities in the plant that could cause damage to people, things or animals.

4.3.1 Electrical wiring diagram

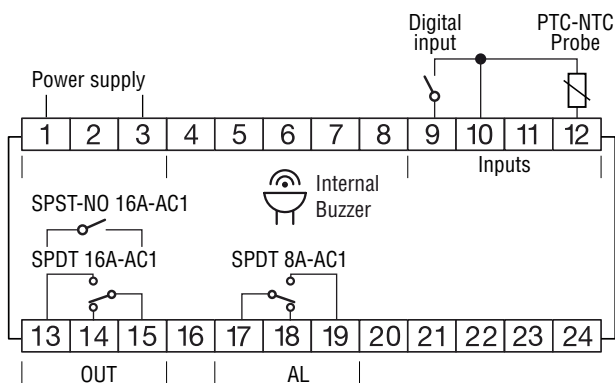

5. FUNCTIONS

5.1 Measuring and visualization

Through the $SEnS$ parameter is possible to select the type of probe connected to the instrument:

PTC Thermistors KTY81-121;

NTC Thermistors 103AT-2.

Once the probe type has been selected, through the parameter $Unit$ is possible to select the measurement temperature unit ($^{\circ}C$ or $^{\circ}F$) and, through dP parameter, the desired measurement resolution ($OFF = 1^{\circ}$; $On = 0.1^{\circ}$).

Through the parameter $OFFS$ the instrument allows re-calibrate the measure in order to fit the application needs, .

Using FIL parameter can be set a software filter for measuring the input values in order to decrease the sensibility to rapid temperature changes (increasing the sampling time).

Must also be noted that the probe measure display can be changed by the *Defrost display lock* function via the dLo parameter (see paragraph 5.4).

5.2 Temperature control

The instrument controls the temperature with an **ON/OFF action** and operates on the **OUT** output depending on the probe measuring, the **SP** Set Point, the $HSEt$ intervention differential (Hysteresis) and the $Func$ function mode.

Depending on the function mode programmed at $Func$ parameter, the differential is automatically considered by the controller with positive values for Cooling actions ($Func = Cool$) or with negative values for Heating actions ($Func = HEAT$).

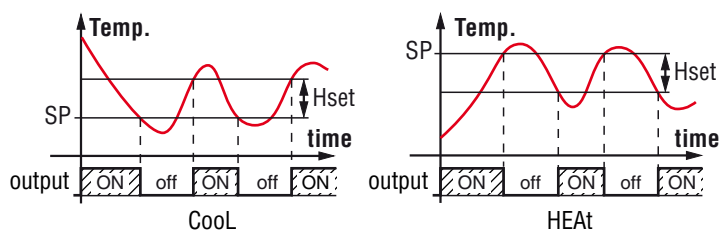

In the event of probe error, it is possible to set the instrument so that that the output **OUT** continues working in cycles according to the times programmed in the parameter t_{onE} (**activation time**) and t_{offE} (**deactivation time**).

If an error occurs on the probe the instrument activates the output for the t_{onE} time, then deactivates it for the t_{offE} time and so on whilst the error remains.

Programming $t_{onE} = OFF$ in probe error conditions the output remains switched OFF.

Programming instead t_{onE} to any value and $t_{offE} = OFF$ in probe error conditions the output remains switched.

Remember that the temperature control function can be conditioned by the *Compressor protection function and delay at power-on* function described below.

5.3 Compressor protection function and power-on delay

The *Compressor Protection* function aims to avoid repeated compressor start-ups controlled by the instrument in Cooling applications.

This function foresees a time control on the **OUT** output activation despite the requests of the temperature controller.

The protection consists of preventing the output being activated during the time set at the parameter PtC and counted

depending on what has been programmed at the parameter PSC and therefore that any activation occurs only after the PtC time has elapsed.

If during the power ON delay phase, the controller request should disappear due to an inhibition caused by the compressor protection function, the foreseen output start up is naturally cancelled.

Using the parameter PSC is possible to set the type of compressor protection and therefore from when the inhibition time PtC must start. PSC parameter can be set as:

1 Power ON delay;

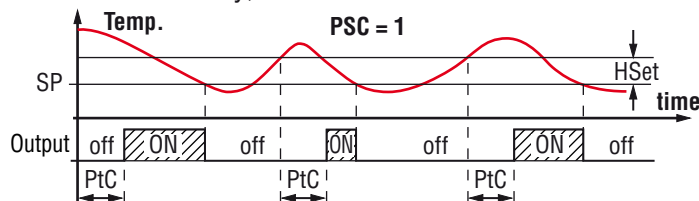

2 Delay after power OFF;

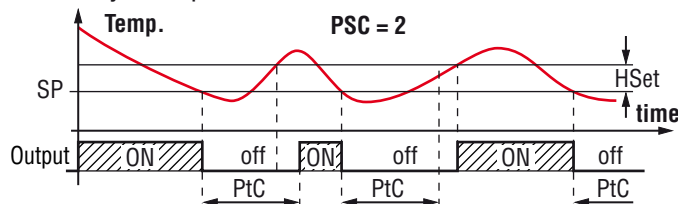

3 Delay between power ON phases.

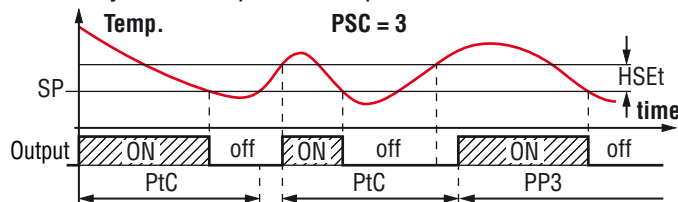

The function is disabled by programming $PtC = 0$.

During the output power ON delay caused by the "Compressor Protection" function, the LED **OUT** flashes.

It is also possible to prevent the output activation at instrument power ON, for the time set at the parameter od . The power ON delay function is disabled by $od = OFF$.

During the power ON delay phase the display shows the indication od alternated to the normal visualisation.

5.4 Defrost control

5.4.1 Automatic defrosts

The automatic defrost control is achieved by stopping the compressor and occurs according to this parameters:

dCt Defrost interval computation:

rt = Based on total functioning time (instrument ON);

ct = Based on compressor running time only (output ON).

dint Interval between defrost cycles;

dEFE Length of defrost cycles.

The instrument switches OFF the output for the time $dEFE$ at every $dint$ time (of total time functioning if $dCt = rt$ or of compressor running time if $dCt = ct$).

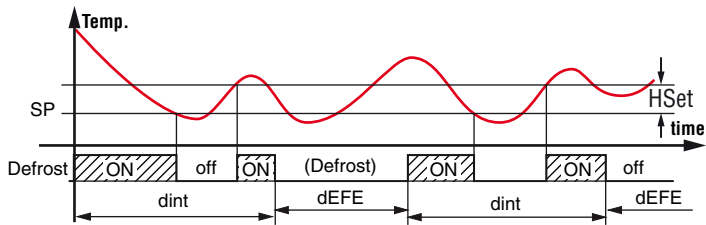

Example with $dL = rt$.

The occurring defrost cycle is pointed out by the LED ✨.

Through parameters dL_0 , Etd_u and $dALd$ is possible to define the display behaviour during defrost.

The dL_0 parameter locks the visualization on the last temperature reading ($dL_0 = \text{on}$) during all the defrost cycle until, at the end of defrost, the temperature reaches the value $[SP + Etd_u]$ or is ended the time set on parameter $dALd$.

Or it permits the visualization of label dEF ($dL_0 = \text{Lb}$) during the defrost cycle and, after the defrost, of label $PdEF$ until, at the end of defrost, the temperature reaches the value $[SP + Etd_u]$ or is ended the time set at parameter $dALd$.

When $dL_0 = \text{off}$ the display continues showing the temperature measured by the probe during the defrost cycle.

Note: The temperature alarms are disabled during the whole defrost cycle and also afterwards for the time set at the parameter $dALd$.

5.4.2 Manual defrost

To start a manual defrost cycle, press the key when the instrument is not in programming mode and keep it pressed for about 5 s after which, if the conditions are correct, the ✨ LED lights up and the instrument performs a defrost cycle.

The defrost cycle start/stop commands can also be given by a correctly programmed digital input (see paragraph 5.6).

5.5 Alarm functions

The alarm functions of the instrument act on the **AL** LED, on the **internal buzzer** (if present) and on the **AL** output (if present).

The buzzer is activated in alarm conditions and can be disabled (alarm silencing) manually by pressing any of the instrument keys.

To point out an alarm condition the instrument turns ON the **AL** LED, to signal a silenced alarm condition it causes the **AL** LED to flash,

The **AL** output is active in alarm status and cannot be disabled manually, it is therefore disabled only when the alarm status has ceased.

The alarm conditions of the instrument are:

- $E11/-E1$ Probe errors;
- $H1/L0$ Temperature alarms;
- External alarms AL .

5.5.1 Temperature alarms

The temperature alarms, that are relative type, work according to the probe measurement, the alarm thresholds set at parameters HRL (maximum alarm) and LRL (minimum alarm) and the relative differential dRL .

Using some parameters it is also possible to delay the enabling and the intervention of these alarms:

PAL Is the temperature alarm exclusion time on switching on the instrument if the instrument is in alarm status when it is switched on;

dALd Is the temperature alarm exclusion time at the end of defrosting;

ALd Is the temperature alarm delay activation time.

The temperature alarm is enabled at the end of exclusion time and is enabled after the ALd time when the temperature measured by the probe exceeds the value $[SP + HRL]$ or goes below the value $[SP - LRL]$.

The maximum and minimum temperature alarms can be disabled setting the relative parameters $HRL/LRL = \text{OFF}$.

At the same time as the signalling of the alarm device (buzzer and **AL** output), the instrument signals the alarm by turning ON the **AL** LED and shows on the display:

- The label $H1$ alternated to the measured temperature for maximum alarm;
- The label $L0$ alternated to the measured temperature for the minimum alarm.

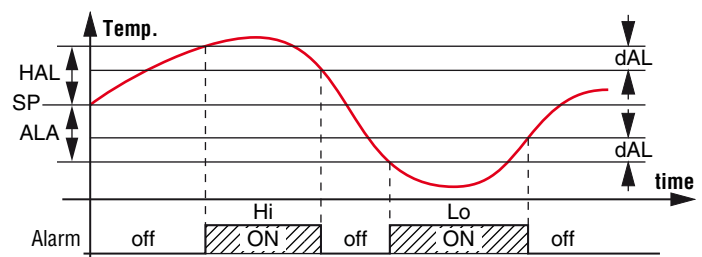

5.5.2 External alarm

The instrument can signal an external alarm activated by the digital input (when its function is programmed as $dIF = 3$ see paragraph 5.6).

Simultaneously with the alarm signal (buzzer and/or output), the instrument points out the alarm by turning on the **AL** LED and showing on the display the label AL alternated to the measured temperature.

5.6 Digital input

The digital input present on the instrument accepts free of voltage contacts, the function carried out is defined by the parameter dIF can be configured for the following functions:

- 0** Digital input not active;
- 1** Defrost start command with NO contact: the input closure causes the start of a defrost cycle;
- 2** Defrost end command with NO contact: the input closure causes the end of the active defrost cycle or the defrosts inhibition;
- 3** External alarm signal with NO contact: closing the input the alarm is activated and the instrument displays the label **AL** alternated to the measured temperature;
- 1** Defrost start command with NO contact: similar to $dIF = 1$ but with reversed logic function;
- 2** Defrost end command with NC contact: similar to $dIF = 2$ but with reversed logic function;
- 3** External alarm signal with NO contact: similar to $dIF = 3$ but with reversed logic function.

5.7 Functioning of key

The key function can be defined by the parameter $USrb$ and can be configured for the following functions:

OFF The key carries out no function.

- 1** Pressing the key for at least 1 second, it is possible to switch the instrument from the **ON** status to **Stand-by** status and vice versa.

6. ACCESSORIES

The instrument is equipped with a 5-pole connector which can be used to link some external accessories that allow to perform some functions in “off-line” mode.

6.1 Parameters configuration by “A01”

The **A01** device can be linked to the 5 poles connector to transfer from and toward the instrument the functioning parameters.



This device it is mainly usable for the serial programming of some instruments which need to have the same parameters configuration or to keep a copy of the parameters setting of an instrument and allow its rapid retransmission.

The same device allows to connect a PC via USB with which, through the appropriate configuration software for “AT UniversalConf tools”, the operating parameters can be configured.

To use the device A01 it is necessary that the device or instrument are being supplied directly or through the key.

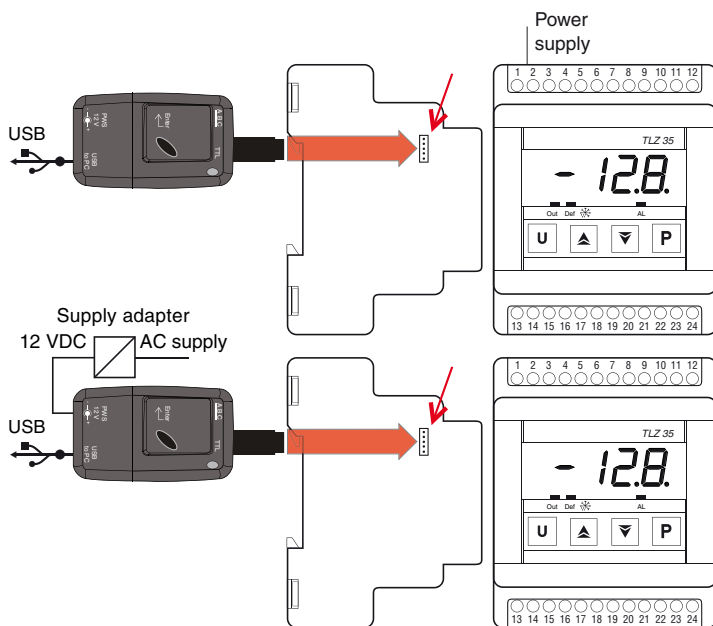

For additional info, please have a look at the A01 instruction manual.

7. PROGRAMMABLE PARAMETERS TABLE

Here below is a description of all the parameters available on the instrument. Some of them may not be present, either due to the fact they depend on the type of instrument or because they are automatically disabled as unnecessary.

Parameter	Description	Range	Default	Note	
1	<i>SPLL</i>	Minimum Set Point	-58.0 ÷ SPHL	-50.0	
2	<i>SPHL</i>	Maximum Set Point	SPLL ÷ 302.0	100.0	
3	<i>SEnS</i>	Probe Type	Ptc Thermistors PTC KTY81-121; ntc Thermistor NTC 103AT-2	Ptc	
4	<i>DFS</i>	Probe Calibration	-30.0 ÷ 30.0°C/°F	0.0	
5	<i>Unit</i>	Unit of measurement	°C Celsius degrees; °F Farenheit degrees	°C	
6	<i>dP</i>	Decimal point	OFF 1°; On 0.1°	On	
7	<i>FiL</i>	Measurement filter	OFF Function disabled; 0.1 ÷ 20.0 s	2.0	
8	<i>HSEt</i>	Differential	0.0 ÷ 30.0°C/°F	2.0	
9	<i>tOnE</i>	Activation time OUT output for probe broken	OFF Function disabled; 00.01 ÷ 99.59 min.s	OFF	
10	<i>tOFF</i>	Deactivation time OUT output for probe broken	OFF Function disabled; 00.01 ÷ 99.59 min.s	OFF	
11	<i>Func</i>	Function mode OUT output	HEAT Heating; Cool Cooling	Cool	
12	<i>dint</i>	Defrosting interval	OFF Function disabled; 00.01 ÷ 24.00 h.min	6.00	
13	<i>dEFE</i>	Lenght of defrost cycle	0.01 ÷ 99.59 min.s	30.00	
14	<i>dEt</i>	Defrosting intervals Counting mode	rt Total time the instrument has been in ON status; ct Total time the OUT output has been in ON status	rt	
15	<i>dLo</i>	Defrost display Lock	OFF Not active; On Lock on temperature before defrost; Lb Lock on label <i>dEF</i> (during defrost) and <i>PdEF</i> (after post-defrost)	OFF	
16	<i>Etdu</i>	Differential display unlock after defrost	0.0 ÷ 30.0°C/°F	2.0	
17	<i>PSC</i>	Type of compressor protection	1 Delay at switch ON of the compressor; 2 Delay after switch OFF of the compressor; 3 Delay between compressor starts	1	
18	<i>PtC</i>	Compressor protection time	OFF Function disabled; 00.01 ÷ 99.59 min.s	OFF	
19	<i>od</i>	Delay at power on	OFF Function disabled; 00.01 ÷ 99.59 min.s	OFF	
20	<i>HRL</i>	Relative High temperature Alarm threshold	OFF Function disabled; 0.1 ÷ 100.0°C/°F	OFF	
21	<i>LRL</i>	Relative Low temperature Alarm threshold	OFF Function disabled; 0.1 ÷ 100.0°C/°F	OFF	
22	<i>dRL</i>	Temperature Alarms Differential	0.0 ÷ 30.0°C/°F	2.0	
23	<i>RLd</i>	Temperature Alarms delay	OFF Function disabled; 00.01 ÷ 99.59 min.s	OFF	
24	<i>PRL</i>	Temperature Alarms delay at power on	OFF Function disabled; 00.01 ÷ 24.00 h.min	2.00	
25	<i>dRLd</i>	Temperature Alarms delay and unlock display delay after defrost	OFF Function disabled; 00.01 ÷ 24.00 h.min	1.00	
26	<i>U5rb</i>	Function mode key <input type="checkbox"/>	OFF None; 1 ON/STAND-BY	OFF	
27	<i>dIF</i>	Function and function logic of digital input. -1, -2 and -3 functions, are the same of the positive ones, but with inverse logic	0 No function; 1 Start defrost; 2 Stop defrost; 3 external alarm	0	
28	<i>PASS</i>	Access Password to parameter functions	OFF Function disabled; 1 ÷ 9999	OFF	
29	<i>SP</i>	Set Point	SPLL ÷ SPHL	0.0	

8. PROBLEMS, MAINTENANCE AND WARRANTY

8.1 Notifications

8.1.1 Error messages

Error	Reason	Action
$E1 - E1$	The probe may be interrupted (E) or in short circuit (-E) or may measure a value outside the range allowed	Check the probe connection with the instrument and check that the probe works correctly
EEP_r	Internal memory error	Check and if necessary re-programme the parameters function

In probe error status, the **OUT** output behaves as set by the parameters t_{onE} and t_{oFE} .

8.1.2 Other messages

Message	Reason
od	Delay at power-on in progress
H_i	Maximum temperature alarm in progress
L_o	Minimum temperature alarm in progress
RL	Digital Input alarm in progress
dEF	Defrost in progress with $dL_o = L_b$
PdF	Post-defrost in progress with $dL_o = L_b$

8.2 Cleaning

We recommend cleaning of the instrument only with a slightly wet cloth using water and not abrasive cleaners or solvents.

8.3 Warranty and Repairs

The instrument is under warranty against manufacturing flaws or faulty material, that are found within 18 months from delivery date. The warranty is limited to repairs or to the replacement of the instrument.

The eventual opening of the housing, the violation of the instrument or the improper use and installation of the product will bring about the immediate withdrawal of the warranty effects.

In the event of a faulty instrument, either within the period of warranty, or further to its expiry, please contact our sales department to obtain authorisation for sending the instrument to our company.

The faulty product must be shipped to Ascon Tecnologic with a detailed description of the faults found, without any fees or charge for Ascon Tecnologic, except in the event of alternative agreements.

8.4 Disposal

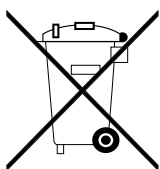

The appliance (or the product) must be disposed of separately in compliance with the local standards in force on waste disposal.

9. TECHNICAL DATA

9.1 Electrical characteristics

Power supply: 12 VAC/VDC, 24 VAC/VDC, 100... 240 VAC $\pm 10\%$;

AC frequency: 50/60 Hz;

Power consumption: about 3 VA;

Inputs: 2 inputs for temperature probes:

PTC (KTY 81-121, 990 Ω @ 25 °C)

NTC (103AT-2, 10 k Ω @ 25°C);

1 free of voltage digital input;

Output: Up to 2 relay outputs:

OUT SPST-NO/SPDT (16A-AC1, 6A-AC3
250 VAC, 1 HP 250 VAC, 1/2 HP 125 VAC)

AL SPDT (8AAC1, 3A-AC3 250 VAC,
1/2 HP 250VAC, 1/3 HP 125 VAC);

Relay output Electrical life:

OUT SPST-NO: 100000 operations;

SPDT: 50000 operations (VDE approval);

AL 100000 operations;

Installation category: II;

Measurement category: I;

Protection class against electric shock: Class II for Front panel;

Isolation: Reinforced insulation between the low voltage part (supply H type and relay outputs) and front panel; Reinforced insulation between the low voltage section (supply type H and relay outputs) and the extra low voltage section (inputs); Reinforced between supply and relay outputs; No insulation between supply F type and inputs.

9.2 Mechanical characteristics

Case: Plastic, self-extinguishing degree: V-0 according to UL 94;

Front protection: IP 40 for indoor locations according to EN 60070-1;

Terminals protection: IP 20 according to EN 60070-1;

Installation: Omega DIN rail mounting;

Terminal block: 24 M3 screw terminals for cables of 0.25 \div 2.5 mm² (AWG22 \div AWG14) with connection diagram;

Dimensions: 70 x 84, depth 60 mm,
(2.76 x 3.31 x 2.36 in.) according to DIN43700;

Weight: 200 g max..

Connections: 0.2 \div 2.5 mm²/AWG 24 \div 14 cables;

Pollution degree: 2;

Operating temperature: 0 \div 50°C;

Operating humidity: 30 \div 95 RH% with no condensation;

Storage temperature: -25 \div +60°C.

9.3 Functional features

Temperature Control: ON/OFF mode;

Defrost control: Interval cycles by stopping compressor;

Measurement range: NTC: $-50 \div +109^{\circ}\text{C}/-58 \div +228^{\circ}\text{F}$,
PTC: $-50 \div 150^{\circ}\text{C}/-58 \div 302^{\circ}\text{F}$;

Display resolution: 1° or 0.1° (range $-99.9 \div +99.9^{\circ}$);

Overall accuracy: $\pm(0.5\% \text{ fs} + 1 \text{ digit})$;

Sampling rate: 130 ms;

Display: 4 Digit Red, height 12 mm;

Compliance: EMC Directive 2004/108/CE (EN55022: class B; EN61000-4-2: 8kV air, 4kV cont.; EN61000-4-3: 10V/m; EN61000-4-4: 2kV supply and relay outputs, 1kV inputs; EN61000-4-5: supply 2kV com. mode, 1 kV\diff. mode; EN61000-4-6: 3V),

LV Directive 2006/95/CE (EN 60730-1, EN 60730-2-9),

Approvals: C-UL (file n. E212227).

10. INSTRUMENT ORDERING CODE

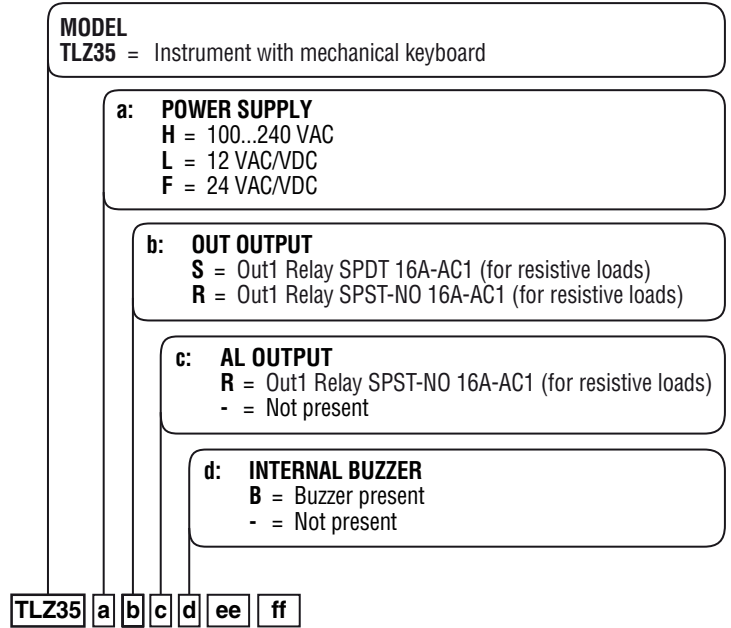

ee: CODES RESERVES; ff: CODES SPECIAUX

