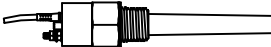

## Table of contents

---

	Page
Safety Notes/ Technical support	2
-----	
Introducion	
Applications/ Versions/ Features	3
-----	
Technical data CN 7100	
	
Dimensions	4
Electrical data	5
Mechanical data	6
Environmental and Process conditions	6
Approvals	7
-----	
Mounting	7
-----	
Electrical installation	9
-----	
Operation	13
-----	
Troubleshooting	18
-----	
Maintenance	19
-----	
Notes for use in Hazardous Locations	20

Subject to technical change.  
 All dimensions in mm (inch).

We assume no liability for typing errors.  
 Different variations than specified are possible.  
 Please contact our technical consultants.

## Safety notes / Technical support

---

### Notes

- Installation, maintenance and commissioning may be accomplished only by qualified technical personnel.
- The product must be used only in the manner outlined in this instruction manual.
- This product is intended for use in industrial areas. Operation of this equipment in a residential area may cause interference to several frequency based communications.

Special attention must be paid to warnings and notes as follows:

#### WARNING



Relates to a caution symbol on the product: A failure to observe the necessary precautions can result in death, serious injury and/or considerable material damage.

#### WARNING



Relates to a caution symbol on the product: Risk of electric shock

#### WARNING



A failure to observe the necessary precautions can result in death, serious injury and/or considerable material damage.

This symbol is used, when there is no corresponding caution symbol on the product.

#### CAUTION

A failure to observe the necessary precautions can result in considerable material damage.

### Safety symbols

In manual and on product

Description



CAUTION: refer to accompanying documents (manual) for details.



Earth (ground) Terminal



Protective Conductor Terminal

### Technical support

Please contact your local supplier (for address see [www.uwt.de](http://www.uwt.de)). Otherwise you can contact:

UWT GmbH  
 Westendstr. 5  
 D-87488 Betzigau

Tel.: 0049 (0)831 57123-0  
 Fax: 0049 (0)831 76879  
[info@uwt.de](mailto:info@uwt.de)  
[www.uwt.de](http://www.uwt.de)

## Introduction

---

### Applications

CN 7000 is a compact 2-wire capacitance switch for level detection in constricted spaces, applicable in:

- Interfaces, solids, liquids, slurries, and foam
- Foods and pharmaceuticals
- Chemical and petrochemical
- Hazardous areas

### Versions

- Integral cable version with stainless steel process connection and probe options of PPS or PVDF
- Enclosure version (thermoplastic polyester enclosure) with stainless steel process connection in combination with a PPS or PVDF probe.
- Enclosure version (thermoplastic polyester enclosure) with fully synthetic process connection combined with a PPS probe.

### Features

- NPT, R (BSPT), G (BSPP) process connections.
- Corrosion resistant construction, PPS, and 316L stainless steel (optional PVDF wetted parts).
- Non-polarized, solid-state switch or relay output (enclosure version with fully synthetic process connection only).

## Technical data - Dimensions

CN 7100  
 Integral Cable version

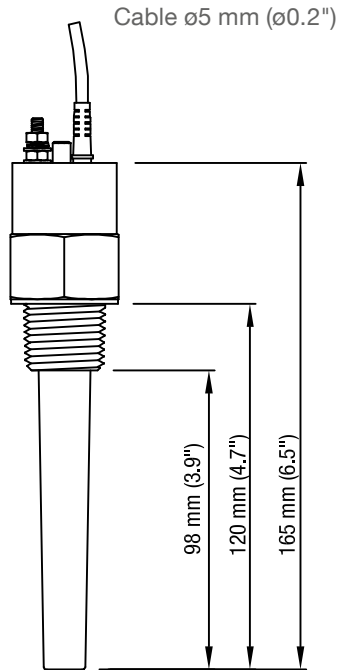

CN 7100  
 Enclosure version

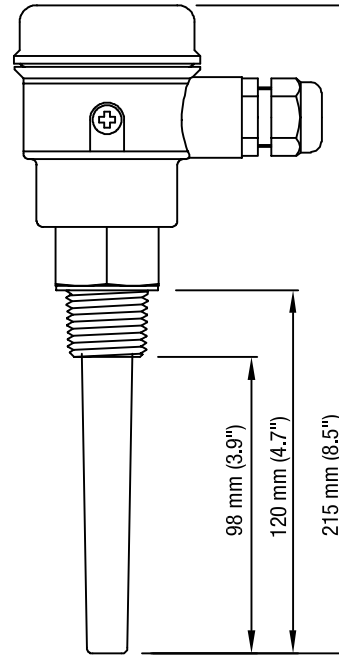

¾" NPT: 36 mm (1.4")  
 R 1": 36 mm (1.4")  
 G 1": 41 mm (1.6")

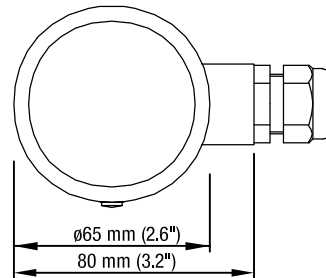
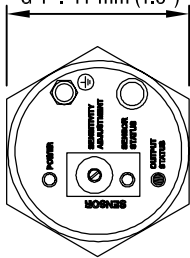

## Technical data - Electrical data

### Electrical

	<b>Integral cable version or Enclosure version</b> with stainless steel process connection	<b>Enclosure version</b> with PPS process connection
<b>Power supply</b>		
Standard	12 - 33 V DC	12 - 33 V DC
Intrinsically safe	10 - 30 V DC Intrinsically safe barrier required  For ATEX: $U_i=30\text{ V}$ $I_i=120\text{ mA}$ $P_i=1,5\text{ W}$ $C_i=2,1\text{ nF}^*$ $L_i=1,3\text{ mH}$  For INMETRO: $U_i=30\text{ V}$ $I_i=200\text{ mA}$ $P_i=1.5\text{ W}$ $C_i=2\text{ nF}^*$ $L_i=1\text{ mH}$  * For an integral cable with a length of more than 1.5m a capacitance of 0.3 nF/ m shall be added  For FM/ CSA: see page 12	-
<b>Alarm Outputs</b>		
mA	4/ 20 mA or 20/ 4 mA 2-wire current loop detection	4/ 20 mA or 20/ 4 mA 2-wire current loop detection
Solid-state switch (Standard)	30 V DC/ 30 V AC 82 mA max. Limited to 30 V DC/ 16 V AC 82 mA max. in wet locations	-
Solid-state switch (Intrinsically safe)	30 V DC max. Intrinsically safe barrier required. The power supply circuit is infallibly galvanically isolated from the solid-state switch circuit.  For ATEX: $U_i=30\text{ V}$ $I_i=200\text{ mA}$ $P_i=350\text{ mW}$ $C_i=0^*$ $L_i=0$  For INMETRO: $U_i=30\text{ V}$ $I_i=200\text{ mA}$ $P_i=1.5\text{ W}$ $C_i=2\text{ nF}^*$ $L_i=1\text{ mH}$  * For an integral cable with a length of more than 1.5m a capacitance of 0.3 nF/ m shall be added  For FM/ CSA: see page 12	-
Relay output	-	-
- max. switching voltage		60 V DC or 30 V AC; limited to 30 V DC/ 16 V AC in wet locations
- max. switching current		1 A
- max. switching power		60 W
Repeatability	2 mm (0.08")	2 mm (0.08")

## Technical data - Mechanical data / Operating conditions

### Mechanical

Common probe/ wetted parts                      PPS process connection and PPS sensor  
 or 316L process connection and PPS or PVDF sensor

Metal process connection seal:  
 Standard is FKM (e.g. Viton).  
 FFKM (e.g. Kalrez) is optional.

#### Integral cable version

- Integral cable body	316L stainless steel
- Process connection	316L stainless steel, 3/4" NPT or R 1" (BSPT), or G 1" (BSPP)
- Connecting cable	1 m (3.3 ft) of 4 conductor, 22 AWG, shielded, polyester jacket

#### Enclosure version

- Housing	VALOX® (thermoplastic polyester)
- Lid	Transparent thermoplastic polycarbonate (PC)
- Process connection	316L stainless steel, 3/4" NPT or R 1" (BSPT), or G 1" (BSPP) or PPS process connection, 3/4" NPT or R 1" (BSPT)
- Wiring	Internal 5-point terminal block 1/2" NPT wiring entrance (optional M20 x 1.5" cable entry)

### Environmental

#### Ambient temperature

Integral cable version and  
 Enclosure version with stainless steel process connection:  
 -30 to +85°C (-22 to +185°F)  
 -20 to +85°C (-4 to +185°F) with option FFKM seal O-ring

Enclosure version with PPS process connection:  
 -10 to +85°C (+14 to +185°F)

With ATEX approval:  
 Depending on Surface Temperature and Temperature Class,  
 details see page 22.

#### Ingress protection:

- Enclosure version	Type 4/ NEMA 4/ IP68
- Integral cable version	Type 4/ NEMA 4/ IP65, with FM approval limited to "Indoor use"

#### Installation category

I

#### Pollution degree

4

### Process Conditions

Relative dielectric constant                      1.5 minimum

#### Process Temperature

Integral cable version and  
 Enclosure version with stainless steel process connection:  
 -30 to +100°C (-22 to +212°F)  
 -20 to +100°C (-4 to +212°F) with option FFKM seal O-ring

Enclosure version with PPS process connection:  
 -10 to +100°C (+14 to +212°F)

With ATEX approval:  
 Depending on Surface Temperature and Temperature Class,  
 details see page 22.

#### Pressure (vessel)

-1 to 10 bar (146 psi) gauge, nominal

## Approvals / Mounting

### Approvals

	PPS process connection, enclosure version	Stainless steel process connection, enclosure version and internal cable version
General Purpose	CE, FM, CSA	CE, FM/ CSA, TR-CU
Intrinsically Safe (intrinsic safety barrier required)	-	ATEX II 1G 1/2G 1D 1/2D FM/ CSA Class I, II, III, Div. 1, Gr. A-G INMETRO TR-CU
Marine	-	Lloyds Register of Shipping, Categories ENV1, ENV2 and ENV5
Overfill protection	WHG	WHG

**Note:**

EMC testing was conducted on the CN 7000 metal version while mounted in a metallic vessel and wired using shielded cable. The sensitivity was set by turning sensitivity potentiometer 2 turns counter-clockwise from the set point.

## Mounting



### General Safety Instructions

Installation shall only be performed by qualified personnel and in accordance with local governing regulations.

This product is susceptible to electrostatic shock. Follow proper grounding procedures.



### Additional Safety Instructions for Hazardous Locations

see page 20ff

## Location

The CN 7000 is normally mounted into the vessel top (high detection alarm) or through the tank wall at the detection level (high or low detection alarm).

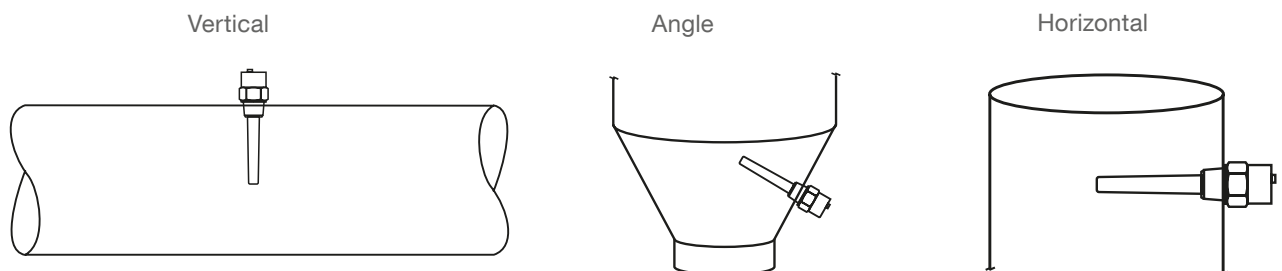

## Mounting

### Installation Features and Restrictions

**Note:** Mounting diagrams apply to intergal cable version and enclosure version.

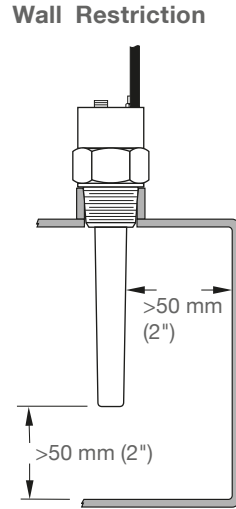
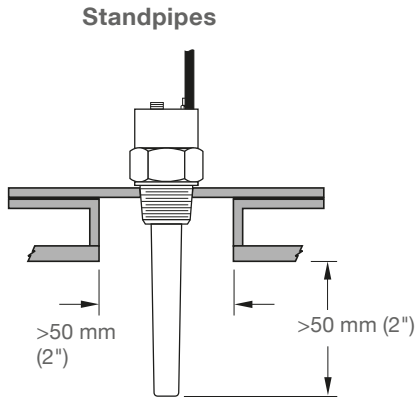

### Multiple Units

When using multiple units, sensors must be 100 mm apart. Mount diagonally if vertical space is restricted.

### Process cautions for solids

Consider material surface configuration when installing unit

Protect probe from falling material

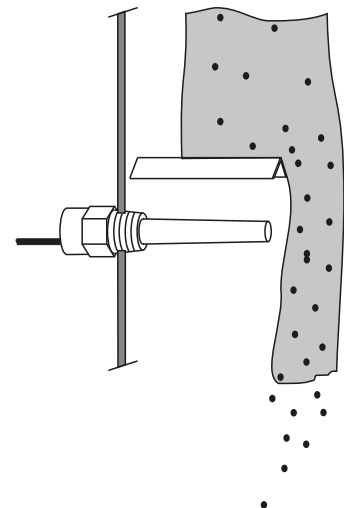
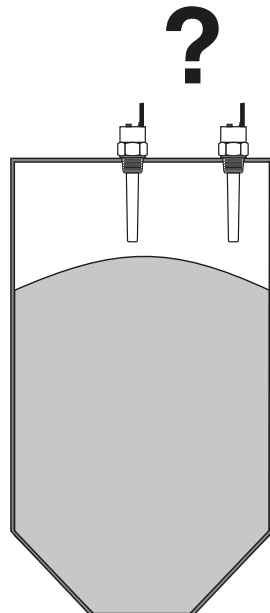
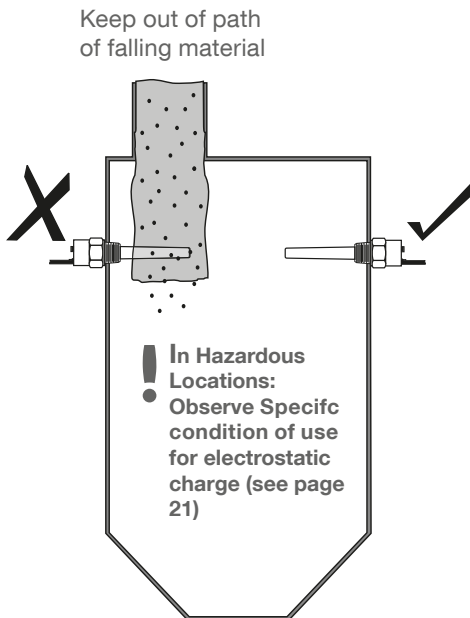

Avoid areas where material build up occurs.

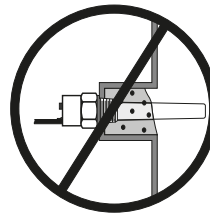
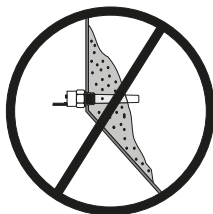



## Electrical installation

---



### General Safety Instructions

The DC input terminal shall be supplied from a source providing electrical isolation between the input and output, in order to meet the applicable safety requirements of IEC 61010-1.

A wet location is a location where water or other conductive liquid may be present and is likely to increase the risk of electric shock.



### Additional Safety Instructions for Hazardous Locations

see page 20 and following pages

## Electrical installation

### Integral Cable Version

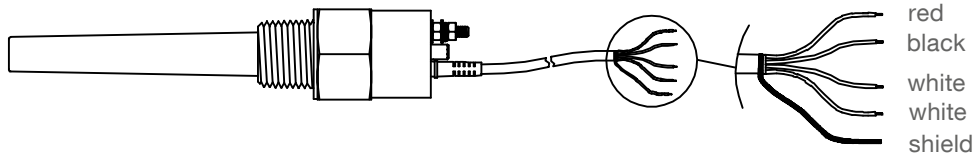

### Operation with solid state switch/ relay

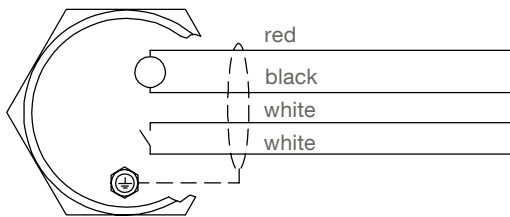

Shield is internal connected to ground.  
 It is recommended to use a shielded cable for stable measurement.

red/ black	white/ white
<b>Supply:</b> 12 - 33V DC 10 - 30V DC intrinsic safe*	<b>Output:</b> <b>Solid state switch*</b> Observe protection (see below). Max. 30 V DC/ 30 V AC, 82 mA Limited to 30 V DC/ 16 V AC, 82 mA in wet locations
Polarity determines output logic, see table below	
* For intrinsic safe operation an intrinsic safety barrier is required Ratings $U_i$ , $I_i$ , $P_i$ , $C_i$ , $L_i$ of power supply and solid state switch: see page 5	

### Operation with 4/ 20 mA loop

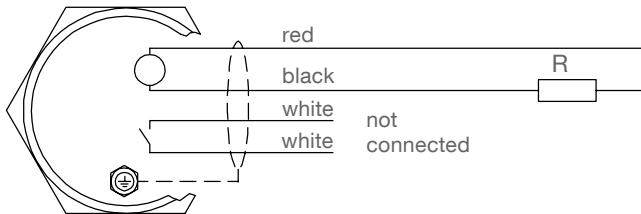

Shield is internal connected to ground.  
 It is recommended to use a shielded cable for stable measurement.

<b>Supply:</b> 12 - 33V DC 10 - 30V DC intrinsic safe* Polarity determines output logic, see table below
* For intrinsic safe operation an intrinsic safety barrier is required. Ratings $U_i$ , $I_i$ , $P_i$ , $C_i$ , $L_i$ of power supply: see page 5

$$R_{max} = (V_{supply} - 12 V) / 20 mA$$

Example: 24 V supply allows  $R_{max}$  of 600 Ohms

### Output logic

	Low liquid level		High liquid level	
	FSL	FSH	FSL	FSH
Yellow LED	○	☀	☀	○
Status	FSL	FSH	FSL	FSH
Supply polarity (cable colour)	red + black -	red - black +	red + black -	red - black +
Red LED	○	☀	☀	○
Solid state switch	— / —	— / —	— / —	— / —
4/ 20 mA loop	4 mA	20 mA	20 mA	4 mA

FSL = Fail safe low FSH = Fail safe high

### Protection of Solid State Switch

Observe a Protection diode in case of connecting an external relay to the Solid state switch

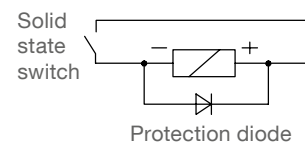

## Electrical installation

### Enclosure Version

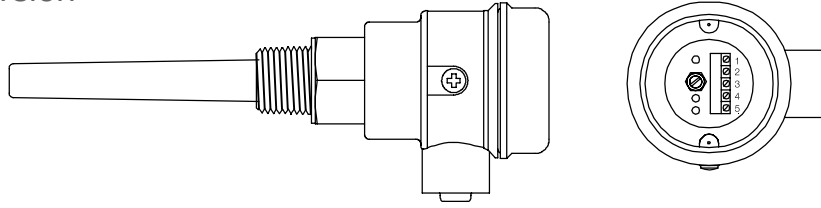

### Operation with solid state switch/ relay

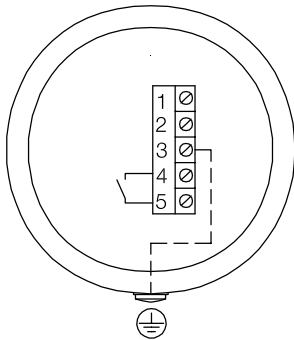

Terminal 3 is internal connected to ground. It is recommended to use a shielded cable for stable measurement.

Terminal 1, 2	Terminal 3	Terminal 4, 5
<b>Supply:</b> 12 - 33 V DC 10 - 30 V DC intrinsic safe*  Polarity determines output logic, see table below	cable shield connection  connect to ground	<b>Output:</b>  <b>Solid state switch *</b> Present with stainless steel process connection. Observe protection (see below). Max. 30 V DC/ 30 V AC, 82 mA, limited to 30 V DC/ 16 V AC, 82 mA in wet locations  <b>Relay</b> Present with PPS process connection. Intrinsic Safety operation not available. Max. 60 V DC or 30 V AC; limited to 30 V DC/ 16 V AC in wet locations, Max. 1 A, 60 W
* For intrinsic safe operation an intrinsic safety barrier is required Ratings $U_i$ $I_i$ $P_i$ $C_i$ $L_i$ of power supply and solid state switch: see page 5		

### Operation with 4/ 20 mA loop

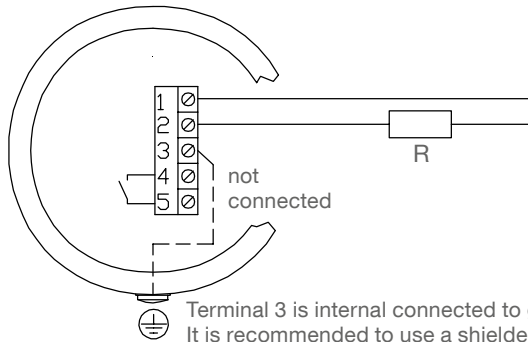

Terminal 3 is internal connected to ground. It is recommended to use a shielded cable for stable measurement.

$$R_{max} = (V_{supply} - 12 V) / 20 mA$$

Example: 24 V supply allows  $R_{max}$  of 600 Ohms

<b>Supply:</b> 12 - 33V DC 10 - 30V DC intrinsic safe* Polarity determines output logic, see table below  * For intrinsic safe operation an intrinsic safety barrier is required. Ratings $U_i$ $I_i$ $P_i$ $C_i$ $L_i$ of power supply: see page 5
--

### Output logic

Yellow LED				
Status	FSL	FSH	FSL	FSH
Supply polarity (Terminal)	1 + 2 -	1 - 2 +	1 + 2 -	1 - 2 +
Red LED				
Solid state switch				
4/ 20 mA loop	4 mA	20 mA	20 mA	4 mA

FSL = Fail safe low FSH = Fail safe high

### Protection of Solid State Switch

Observe a Protection diode in case of connecting an external relay to the Solid state switch

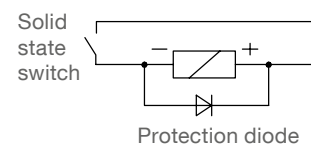

## Electrical installation

### FM/ CSA Approval Connection drawing

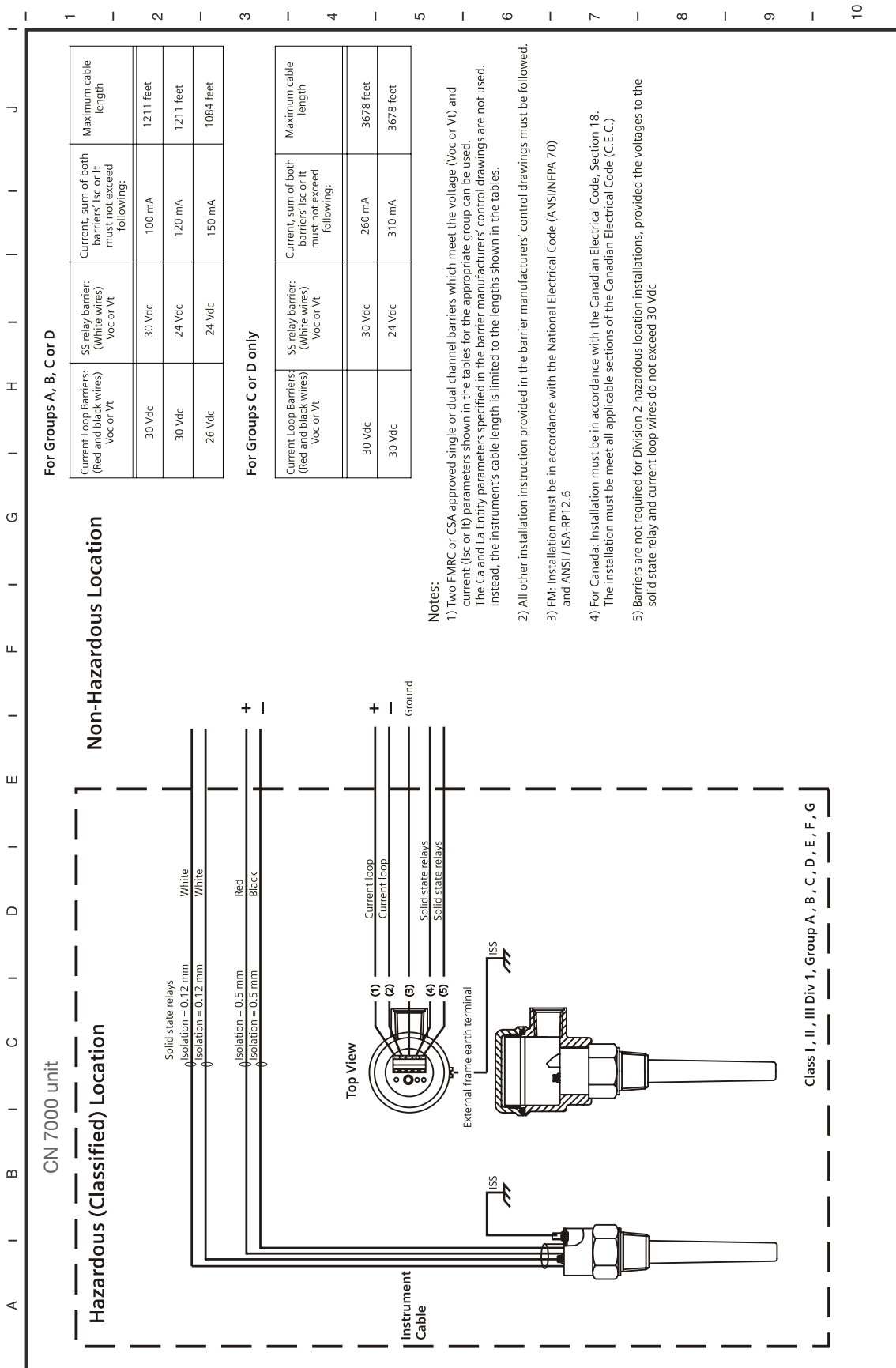

## Operation

### Settings

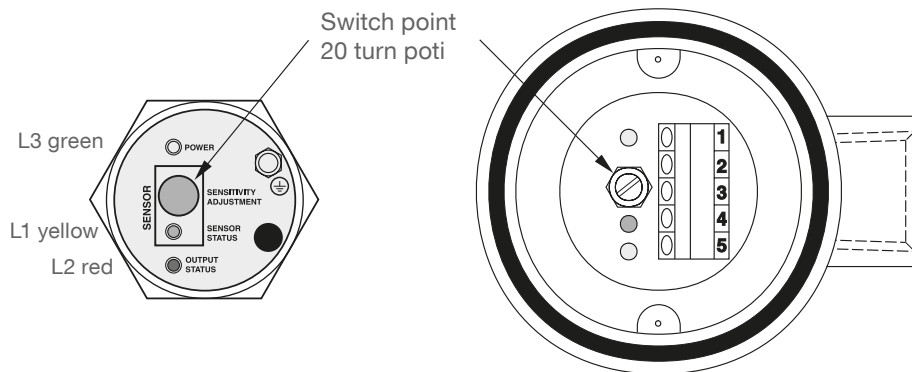

**LEDs**  
 L1: Sensor status  
 ON if sensor is detected as covered (capacitance on sensor is greater than setted switchpoint)  
 L2: Signal output  
 ON if current loop has 20 mA/ Solid state switch is closed.  
 L3: Power supply  
 ON if power is present

### Output logic (Failsafe High/ Failsafe Low)

See table on page 10 and 11.

## Operation

### Switchpoint Adjustment

Select the switchpoint adjustment according to the application as follows:

Application	Material	Adjustment conditions
General	<ul style="list-style-type: none"> <li>• Dry solids</li> <li>• Low viscosity liquids</li> </ul>	Sensor uncovered
Demanding	<ul style="list-style-type: none"> <li>• Hygroscopic/ wet solids</li> <li>• High viscosity and high conductivity liquids</li> </ul>	Sensor immersed and then uncovered, retaining max. possible material buildup
Interface detection	<ul style="list-style-type: none"> <li>• Ignoring liquid A/ detecting liquid B</li> <li>• Ignoring foam/ detecting liquid</li> </ul>	Immerse sensor in liquid A or foam

### General applications

<p><b>1. Ensure material level is well below the probe</b></p>	<p>The unit will calibrate to an uncovered probe.</p>									
<p><b>2. Adjust switchpoint with poti</b></p>	<p>If LED L1 (yellow) is OFF, turn poti clockwise until L1 is ON.</p> <p>Turn poti counter clockwise until L1 just stops glowing.</p> <p>Turn poti further counter clockwise:</p> <table border="1" data-bbox="507 1464 892 1653"> <thead> <tr> <th>Dielectric constant of material</th> <th>Number of turns</th> </tr> </thead> <tbody> <tr> <td>&lt;2</td> <td>¼</td> </tr> <tr> <td>2 ... 4</td> <td>½</td> </tr> <tr> <td>&gt;4</td> <td>1</td> </tr> </tbody> </table> <p>Depending on the application and the required switchpoint the number of turns can be varied.</p>	Dielectric constant of material	Number of turns	<2	¼	2 ... 4	½	>4	1	<p>Poti</p> <p>L1 yellow</p>
Dielectric constant of material	Number of turns									
<2	¼									
2 ... 4	½									
>4	1									
<p><b>Switchpoint adjustment is finished</b></p>										

## Operation

### Demanding applications

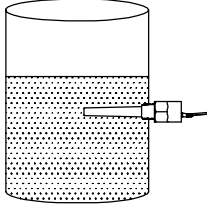
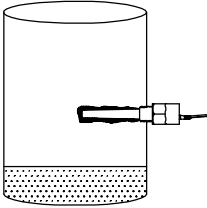
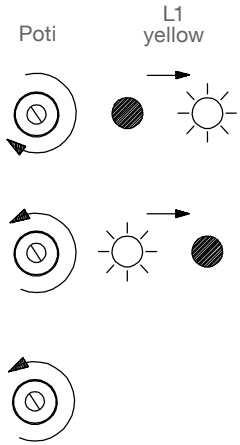
<p><b>1. Ensure material level is well above the probe</b></p>									
<p><b>2. Ensure material level is well below the probe</b></p>	<p>It is important that as much material buildup as possible is retaining on the sensor.</p> 								
<p><b>3. Adjust switchpoint with poti</b></p>	<p>If LED L1 (yellow) is OFF, turn poti clockwise until L1 is ON.</p> <p>Turn poti counter clockwise until L1 just stops glowing.</p> <p>Turn poti further counter clockwise:</p> <table border="1" data-bbox="603 1319 995 1503"> <thead> <tr> <th>Dielectric constant of material</th> <th>Number of turns</th> </tr> </thead> <tbody> <tr> <td>&lt;2</td> <td>¼</td> </tr> <tr> <td>2 ... 4</td> <td>½</td> </tr> <tr> <td>&gt;4</td> <td>1</td> </tr> </tbody> </table> <p>Depending on the application and the required switchpoint the number of turns can be varied.</p> 	Dielectric constant of material	Number of turns	<2	¼	2 ... 4	½	>4	1
Dielectric constant of material	Number of turns								
<2	¼								
2 ... 4	½								
>4	1								
<p><b>Switchpoint adjustment is finished</b></p>									

## Operation

### Interface detection

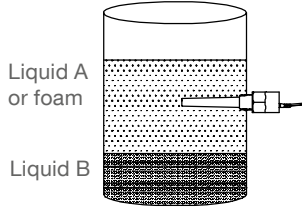
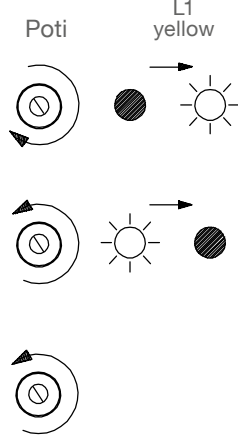
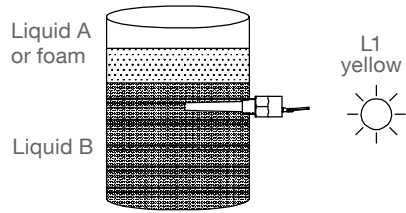
<p><b>1. Immerse probe in liquid A or in foam which should NOT be detected</b></p>	<p>Ensure that liquid A or foam (which should NOT be detected) is covering the probe.</p> <p>Liquid A or foam must have a <b>lower dielectric constant</b> than liquid B, which should be detected.</p> <div style="text-align: right;">  </div>								
<p><b>2. Adjust switchpoint with poti</b></p>	<p>If LED L1 (yellow) is OFF, turn poti clockwise until L1 is ON.</p> <p>Turn poti counter clockwise until L1 just stops glowing.</p> <p>Turn poti further counter clockwise:</p> <table border="1" data-bbox="507 1048 901 1227"> <thead> <tr> <th>Dielectric constant of material</th> <th>Number of turns</th> </tr> </thead> <tbody> <tr> <td>&lt;2</td> <td>¼</td> </tr> <tr> <td>2 ... 4</td> <td>½</td> </tr> <tr> <td>&gt;4</td> <td>1</td> </tr> </tbody> </table> <p>Depending on the application and the required switchpoint the number of turns can be varied.</p> <p>Note: The sensitivity is now setted thus that liquid A or foam is NOT detected.</p> <div style="text-align: right;">  </div>	Dielectric constant of material	Number of turns	<2	¼	2 ... 4	½	>4	1
Dielectric constant of material	Number of turns								
<2	¼								
2 ... 4	½								
>4	1								
<p><b>3. Immerse probe in liquid B which should be detected</b></p>	<p>Ensure that liquid B (which should be detected) is covering the probe.</p> <p>L1 should glow.</p> <div style="text-align: right;">  </div>								
<p><b>Switchpoint adjustment is finished</b></p>									



## Operation

### Measurement through non metal vessel wall

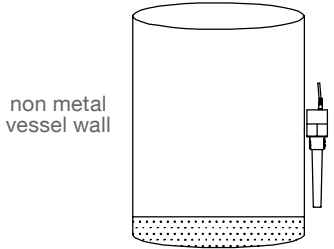
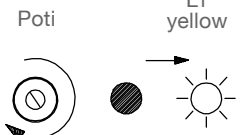
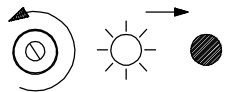
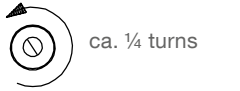
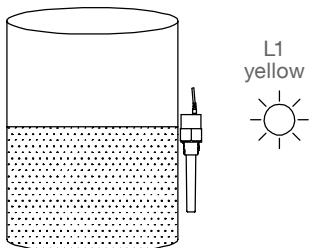
<p><b>1. Ensure material level is well below the probe</b></p>	<p>The unit will calibrate to an uncovered probe.</p> 
<p><b>2. Adjust switchpoint with poti</b></p>	<p>If LED L1 (yellow) is OFF, turn poti clockwise until L1 is ON.</p>  <p>Turn poti counter clockwise until L1 just stops glowing.</p>  <p>Turn poti counter clockwise another ca. ¼ turns. Depending on the application and the required switchpoint the number of turns can be varied.</p> 
<p><b>3. Ensure material level is well above the probe</b></p>	<p>L1 should glow.</p> 
<p><b>Switchpoint adjustment is finished</b></p>	

## Troubleshooting

Symptom	Cause	Action
Green LED off	Proper power not applied to device  Power range must equal 12 to 33 V DC at all times (10 to 30 V DC for IS versions)	Check power source  Minimum 12 V DC on the terminals when the signal current is 20 mA (minimum 10 V DC for IS versions)
Green LED off, with proper supply	Defective component in device.  Connector came loose.	Contact distributor  Refasten connector
Green LED on and Yellow LED on while not responding to product and/ or adjustment	Proper power not applied to device.  Power range must equal 12 to 33 V DC at all times (10 to 30 V DC for IS versions)	Check power source  Minimum 12 V DC on the terminals when the signal current is 20 mA (minimum 10 V DC for IS versions)
Hysteresis region too great	Proper power not applied to device.  Power range must equal 12 to 33 V DC at all times (10 to 30 V DC for IS versions)	Check power source  Minimum 12 V DC on the terminals when the signal current is 20 mA (minimum 10 V DC for IS versions).
Unequal current in red and black wire	Loop circuitry is DC biased w.r.t. ground  Black wire exceeds +36 V DC against ground	Correct loop circuitry.  Remove cause of voltage on the red wire and/or bias
Yellow LED won't come on or off	Defective component in device	Contact distributor
Too much current in loop	Supply voltage too high	Ensure power range equals 12 to 33 V DC at all times (10 to 30 V DC for IS versions).
Red LED lights opposite to the Yellow LED when this is not meant to happen	Incorrect polarity on red and black loop terminals	Reverse polarity on loop terminals
Red and Yellow LEDs are blinking fast	Proper power not applied to device.  Power range must equal 12 to 33 V DC at all times (10 to 30 V DC for IS versions)	Check power source  Minimum 12 V DC on the terminals when the signal current is 20 mA (minimum 10 V DC for IS versions)
Red and Yellow LEDs are blinking while switching	Proper power not applied to device.  Power range must equal 12 to 33 V DC at all times (10 to 30 V DC for IS versions)	Check power source  Minimum 12 V DC on the terminals when the signal current is 20 mA (minimum 10 V DC for IS versions)
Solid state contact does not follow status Red LED	Defective component in device. Probable cause: wrong wiring in this circuit.	Contact distributor

## Troubleshooting / Maintenance

---

Relay state contact does not follow status Red LED	Proper power not applied to device  Power range must equal 12 to 33 V DC at all times  Defective component in device.	Check power source  Minimum 12 V DC on the terminals when the signal current is 20 mA  Contact distributor
Yellow LED is lit while probe is not covered	May indicate significant product buildup.	Rotate sensitivity potentiometer further CCW (counter clockwise) Check sensor tip

## Maintenance

---

The CN 7000 requires no maintenance or cleaning.

## Notes for use in Hazardous Locations

---

### Use of this Manual

For use and assembly, refer to the instructions in this Manual. It does contain all instruction as required by ATEX Directive 2014\_34\_EU, Annex II, 1/0/6 and Ordinance INMETRO n° 179/2010

---

### General notes

Refer to appropriate certificate for application in specific hazardous environment.

The equipment has not been assessed as a safety related device (as referred to by Directive 2014\_34\_EU Annex II, clause 1.5).

The certificate numbers have an 'X' suffix, which indicates that specific condition of use apply. Those installing or inspecting this equipment must have access to the certificates.

---

### ! Qualification of personnel / Servicing / Repair

Installation and inspection of this equipment shall be carried out by suitably trained personnel in accordance with the applicable code of practice (ABNT NBR IEC/EN 60079-14 and ABNT/NBR IEC/EN 60079-17 in Europe).

Repair of this equipment shall be carried out by suitably trained personnel in accordance with the applicable code of practice (e.g. ABNT NBR IEC/EN 60079-19 within Europe).

Components to be incorporated into or used as replacements in the equipment shall be fitted by suitably trained personnel in accordance with the manufacturer's documentation.

Turn off power before servicing any device (the transmitter is in operation when the power supply is switched on). In case of removing the unit from vessel, take care of process pressure and material passing the opening.

---

### ATEX: Certificates / List of Standards

See [www.uwt.de](http://www.uwt.de) for the latest certificates

See EU - Declaration of conformity for the list of standards valid for ATEX certificates

---

### ATEX: Year of manufacturing

Marking on the name plate is done according to IEC 60062 as follows:

Year of manufacturing	2018	2019	2020	2021	2022	2023	2024	2025	2026	2027	2028	2029
Marking code	K	L	M	N	P	R	S	T	U	V	W	X

---

### ATEX: Ex-Marking

Devices with ATEX approval are marked on the name plate as follows:

- II 1 G Ex ia IIC T6...T4 Ga
  - II 1/2 G Ex ia IIC T6...T4 Ga/Gb
  - II 1 D Ex ia IIIC T<sub>200</sub> 85...130°C Da
  - II 1/2 D Ex ia IIIC T<sub>200</sub> 85...130°C Da/Db
-

## Notes for use in Hazardous Locations

### ! ATEX: Permitted zones for installation

Devices can be installed as follows:

	Dust applications		Gas applications	
	marking Da/Db	marking Da	marking Ga/Gb	marking Ga
EPL	Db	Da	Gb	Ga
Category	2D	1D	2G	1G
Zone	21	20	1	0

EPL	Da	Da	Ga	Ga
Category	1D	1D	1G	1G
Zone	20	20	0	0

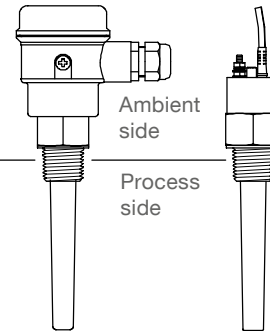

### ! Specific condition of use

**Electrostatic charge** For applications in explosive atmospheres caused by gases, vapours or mists or air/dust mixtures, precautions shall be taken to minimize the risk from electrostatic discharge or propagating brush discharges of non metallic parts of the enclosure.

**Process and ambient temperature** Please check the ambient and process temperatures page 22 for the specific configuration you are about to use or install.

### ! Warnings for installation

**Intrinsically safe supply** For intrinsically safe models, power must be supplied from an Intrinsically Safe power source, otherwise protection is no longer guaranteed.

**Process pressure** The device construction allows process over-pressure up to 10 bar (146 psi). This pressure is allowed for test purposes. The definition of the Ex approvals are only valid for a container-over-pressure between -0.2 .. +0.1 bar (-2.9 .. +1.45 psi). For higher or lower pressures the approvals are not valid.

**Chemical resistance against the medium** If the equipment is likely to come into contact with aggressive substances, then it is the responsibility of the user to take suitable precautions that prevent it from being adversely affected, thus ensuring that the type of protection is not compromised. Aggressive substances: e.g. acidic liquids or gases that may attack metals, or solvents that may affect polymeric materials. Suitable precautions: e.g. establishing from the material's data sheet that it is resistant to specific chemicals.

## Notes for use in Hazardous Locations

- ! Ambient and process temperature range,
- max. Surface Temperature and Temperature Class

### ATEX:

Ambient temperature range	Process temperature range	Max. Surface temperature (EPL Da/Db)	Temperature class (EPL Ga)
-30 to +40°C (-22 to +104°F)	-30 to +75°C (-22 to +167°F) (1)	T <sub>200</sub> 85°C	T6
-30 to +85°C (-22 to +185°F)	-30 to +85°C (-22 to +185°F) (1)	T <sub>200</sub> 130°C	T4

(1) With option FFKM O-ring seal: Lower process temperature limited to -20°C (-4°F)

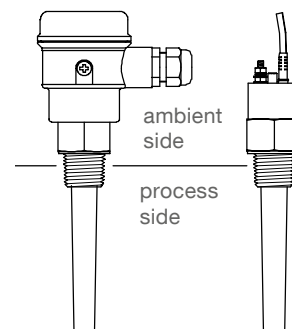

### INMETRO:

Ambient temperature range	Process temperature range	Max. Surface temperature	Temperature class
-40 to +40°C (-40 to +104°F)	-40 to +40°C (-40 to +104°F)	62 °C	T6
-40 to +85°C (-40 to +185°F)	-40 to +100°C (-40 to +212°F)	107 °C	T4

### FM:

Ambient temperature range	Process temperature range	Temperature class
-30 to +85°C (-22 to +185°F)	-30 to +100°C (-22 to +212°F)	T4

### CSA:

Ambient temperature range	Process temperature range	Temperature class
-40 to +85°C (-40 to +185°F)	-40 to +100°C (-40 to +212°F)	T4