

## Table of contents

---

	Page
Overview	P2
-----	
Specification / application	P3
-----	
NB 4000	P4
-----	
Options / Accessories	P6
-----	
Dimensions / materials	P7
-----	
Spare parts	P9
-----	
Electrical installation	P11

Subject to change.

Valid: From 01.04.2014 until 31.03.2015, unless otherwise agreed.

All dimensions in mm (inches).

By publishing this selection list all other lists become invalid.

All prices in Euro, excluding VAT.

We assume no liability for typing errors.

All prices are EXW Betzigau, excluding packaging costs.

Different variations to those specified are possible. Please contact our technical consultants.

## Overview

---

### Features

Continuous level measurement of solids applications

#### Process

- Independent of bulk material properties
- Accurate measurement

#### Service

- Simple installation and commissioning
- Rope and tape version with long service life
- Low maintenance

#### Approvals

- Approval for use in Hazardous Areas

#### Mechanics

- Measurement range up to 30m (100ft)
- 1 1/2" process connection possible
- Aiming flange to be mounted directly on a flat silo roof
- Internal tape cleaner for difficult materials

#### Electronics

- Micro processor controlled measurement
- Diagnostic possibilities
- Output 4-20mA
- Two programmable Relay (can be used as Counting pulse output or as Failure / Upper stop position)



**NB 4100**  
 Rope version  
 Fig. with flange DN 100  
 and PVC sensor weight



**NB 4200**  
 Tape version  
 Fig. with thread connection  
 and stainless steel sensor  
 weight



**NB 4100**  
 Rope version  
 Fig. with aiming flange and  
 stainless steel sensor weight  
 with pin

## Specification / application

### Specification

<b>Process</b>	Measurement range	15m (50ft) or 30m (100ft)
	Process temperature	80°C (176°F)
	Process overpressure	-0,2 .. +0,2 bar (-3.0 .. + 3.0 psi)
	Min. powder density	>300 g/l (18 lb/ft³)
<b>Electronics</b>	Power supply	AC version 115V or 230V 50-60Hz DC version 20 .. 28V
	Output	4-20mA
		2 relais (optional)
<b>Certificate</b>	Dust Ex	ATEX 1/2D FM Cl. II, III Div. 1
	General purpose	CE, FM
		Metrological certification (Belarus)

### Application

#### Solids measurement

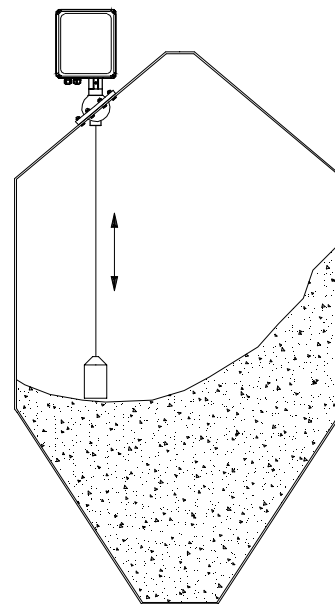
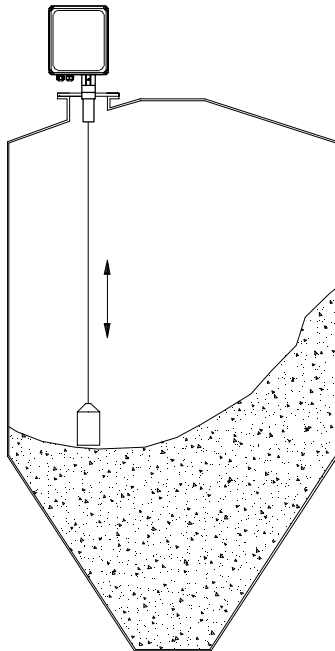

Aiming flange  
screwed directly  
to the silo roof

## NB 4000

---

### NB 4100

Rope version

(fig. with flange DN 100  
and PVC sensor weight)



### NB 4200

Tape version

(fig. with thread connection  
and stainless steel sensor  
weight)



#### Cable entries (by default)

Depending on selected version (options see pos. 26):

CE, ATEX    Screwed cable gland: 1x M25x1.5 and 1x M20x1.5  
Blindplug: 1x M20x1.5

FM            Open conduit ANSI B1.20.1: 1x NPT 3/4" and 1x NPT 1/2"  
Blindplug: 1x NPT 1/2"

**Dimensions** see page P7

## NB 4000

- pos. 1            **Basic type**  
 C **NB 4100** Rope version .....  
 D **NB 4200** Tape version .....
- pos. 2            **Certificate**  
 0 CE .....  
 W ATEX II 1/2 D .....  
 M FM general purpose .....  
 N FM Class II, III Div.1 Group E-G .....
- pos. 3            **Measurement range**  
 1 15m (50ft) .....  
 2 30m (100ft) .....
- pos. 4            **Power supply**  
 1 230V 50-60Hz .....  
 2 115V 50-60Hz .....  
 3 20 .. 28V DC .....
- pos. 5            **Process connection**  
 A Thread R 1 1/2 inch            tapered DIN 2999 .....  
 B Thread NPT 1 1/2 inch        tapered ANSI B1.20.1 .....  
 X Flange DN100 PN16 (EN1092-1) and flange 4" 150lbs ANSI B16.5 (unit is fitting to this flange) .....  
 Y Flange 2" and flange 3" 150lbs ANSI B16.5 (unit is fitting to this flange) .....  
 W Aiming flange (to be mounted directly to the silo roof) <sup>(4)</sup> .....
- pos. 6            **Sensor weight <sup>(1)</sup>**  
 Y without <sup>(2)</sup> .....  
 A PVC <sup>(3)</sup> .....  
 C Stainless steel .....  
 E Folding cover .....

Basic type

<b>NB 4..00</b>							← <b>Order code</b>
Position	1	2	3	4	5	6	

All positions are available in special design (use code "Z").

- (1) For use in Hazardous Locations (Dust Ex): It must be ensured, that no static discharge from the material surface can occur. Sensor weights, which can be used in case of possible static discharge, on request.
- (2) Only for tape version. Including mounting set for sensor weight (see page P9: Sensor weights)
- (3) Does not fit through a 1 1/2 inch nozzle, must be mounted after fixing the unit to the silo
- (4) Mounting without a socket. Including fixing material (screws, sealing etc.)

## Options / Accessories

### Options

- pos. 11      x **Guarantee extension to 5 years** .....  
 Wear and tear parts rope/tape and motor not included
- pos. 21      **Weather protection cover** .....  
 For Ex only approved for Zone 22 or Division 2
- pos. 22      **Internal heater** .....  
 Needed for: ambient temp. <-20°C (-4°F) or condense water inside silo or wet process atmosphere  
 (Note: <-20°C (-4°F) with ATEX or FM Class II on request possible)
- pos. 23      **Length of socket pipe** .....  
 1 200mm (7.87") .....  
 2 500mm (19.7") .....  
 3 1000mm (39.4") .....
- pos. 24      **Pin for sensor weight** .....  
 POM or stainless steel (in accordance to selected sensor weight material, not for pos.6 E)
- pos. 25      **Relais output** .....  
 Second relais (selectable as "Counting pulse output" or as "Failure"/"Upper stop position")
- pos. 26      **Cable entry** .....  
 Selection of the following options only necessary, if a deviation from the default cable gland / conduit is required:  
 0 Screwed cable gland 1x M25x1,5 + 1x M20x1,5 + blindplug 1x M20x1,5 .....  
 A Conduit 1x NPT 3/4"+ 1x NPT 1/2" + blindplug 1x NPT 1/2" .....

### Accessories

#### Fixing material for mounting the unit on a flange

- zu107000      4 bolts M16x60, 8 washers, 4 nuts. Stainless steel. ....

#### Sealings for mounting the unit on a flange

- di300125      Flange sealing for DN100 PN16 / 4" (neoprene) .....  
 di300127      Flange sealing for 2" / 3" 150lbs (neoprene) .....

#### Adapter NPT 1 1/2" to NPT 3"

- zu103100      Thread tapered ANSI B1.20.1, aluminium .....

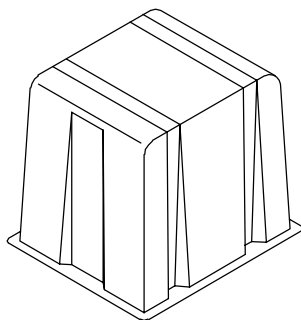

Weather protection cover

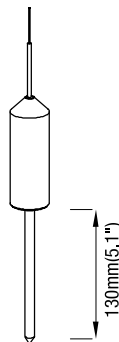

Pin for sensor weight  
 POM or 1.4305 (303)

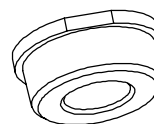

Adapter NPT 1 1/2" to NPT 3"

## Dimensions and materials

### Basic unit

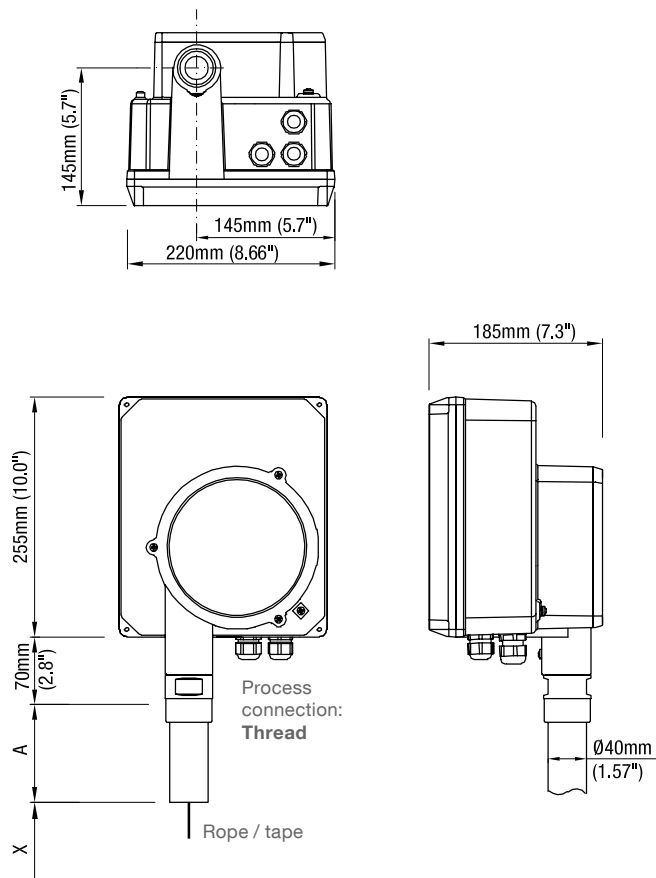

Process connection: **Flange**

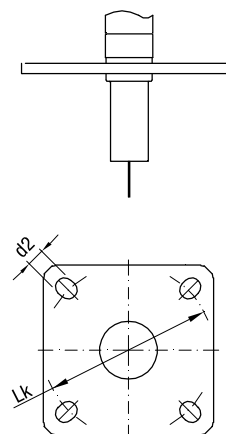

Process connection: **Aiming flange**

To be screwed directly to the silo roof  
 0°-50° adjustable  
 Including screws, nuts and sealing

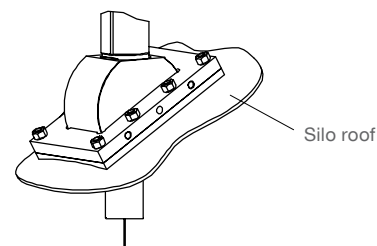

Flange plate outside dimensions:  
 Width x Height: 120mm x 180mm (4.7"x7.1")

### Dimensions

<b>X</b> = Length to bottom of sensor weight (in upper stop position, see next page)	
<b>A</b> = Length of socket pipe 100mm (3.9") Optional 200mm (7.9") / 500mm (19.7") / 1000mm (39.4")	
<b>Flanges</b>	
fitting to: DN100 PN16 / 4" 150lbs	Lk = $\phi$ 180-190.5mm (7.1-7.5") slot d2 = $\phi$ 19mm (0.75")
fitting to: 2" / 3" 150lbs	Lk = $\phi$ 120.7-152.4mm (4.75-6.0") slot d2 = $\phi$ 19mm (0.75")
<b>Rope</b>	$\phi$ 1,0mm (0.04")
<b>Tape</b>	12x0.2mm (0.47x0.008")

### Materials

<b>Housing outside</b>	Aluminium, powder coated
<b>Housing inside</b>	Aluminium
<b>Thread / Flange</b>	Aluminium
<b>Aiming flange</b>	Aluminium / 1.4301 (301)
<b>Rope</b>	1.4401 (316)
<b>Tape</b>	1.4310 (301)

## Dimensions and materials

### Sensor weights

#### Rope version

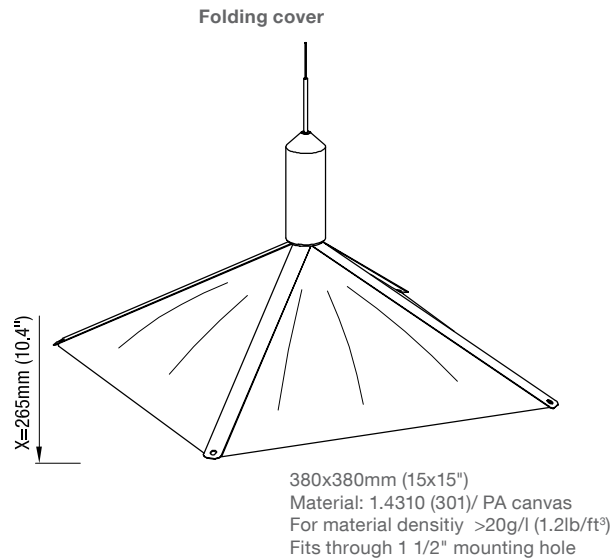
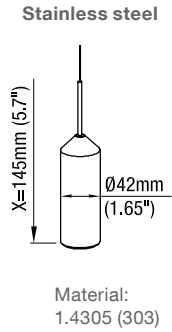
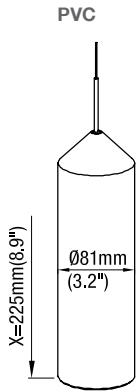

All sensor weights:  
 1,6 kg (3.5 lbs)

#### Tape version

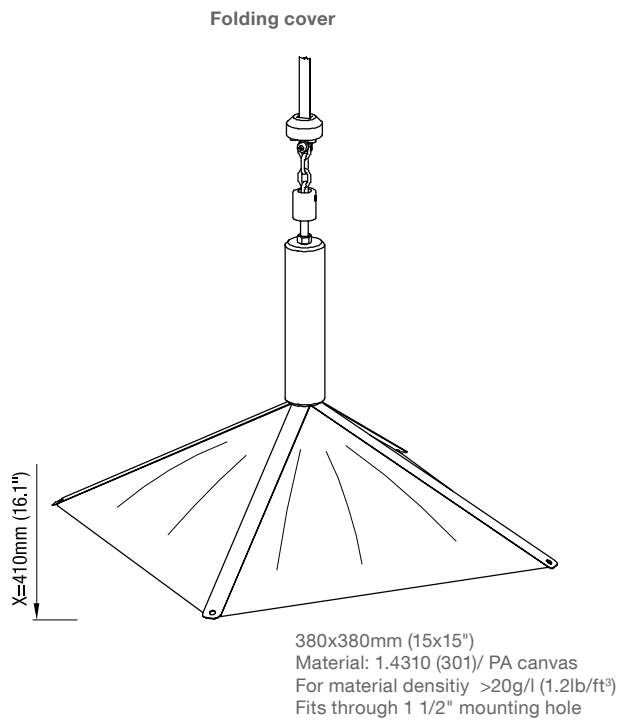
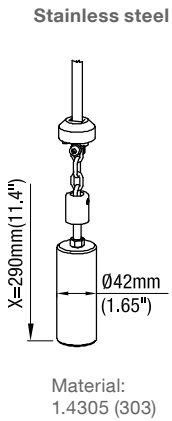
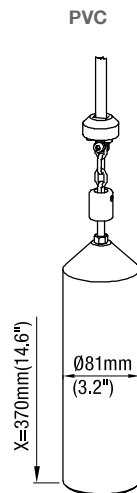

Fixing elements between tape and sensor  
 weight: aluminium / 1.4305 (303)

All sensor weights:  
 1,6 kg (3.5 lbs)



## Spare parts

### Roller

<b>sl103239</b>	Rope roller with 15m rope .....
<b>sl103240</b>	Rope roller with 30m rope .....
<b>sb103239</b>	Tape roller with 15m tape .....
<b>sb103240</b>	Tape roller with 30m tape .....

### Sensor weights

All sensor weights are delivered incl. mounting set for proper fixing to the rope/tape and excl. rope/tape

#### For rope version:

<b>sl103231</b>	PVC without pin .....
<b>sl103232</b>	PVC with pin .....
<b>sl103233</b>	Stainless steel without pin .....
<b>sl103234</b>	Stainless steel with pin .....
<b>sl103235</b>	Folding cover .....

#### For tape version:

<b>sb103231</b>	PVC without pin .....
<b>sb103232</b>	PVC with pin .....
<b>sb103233</b>	Stainless steel without pin .....
<b>sb103234</b>	Stainless steel with pin .....
<b>sb103235</b>	Folding cover .....

### Motor

<b>gm103202</b>	Motor .....
-----------------	-------------

### Electronics

<b>pl103690</b>	230V 50-60Hz	4-20mA	without 2 Relais and without Internal Heater Control .....
<b>pl103691</b>	230V 50-60Hz	4-20mA	with 2 Relais and with Internal Heater Control <sup>(1)</sup> .....
<b>pl103692</b>	115V 50-60Hz	4-20mA	without 2 Relais and without Internal Heater Control .....
<b>pl103693</b>	115V 50-60Hz	4-20mA	with 2 Relais and with Internal Heater Control <sup>(1)</sup> .....
<b>pl103694</b>	20 .. 28V DC	4-20mA	without 2 Relais and without Internal Heater Control .....
<b>pl103695</b>	20 .. 28V DC	4-20mA	with 2 Relais and with Internal Heater Control <sup>(1)</sup> .....

**Required information:** Rope or Tape version; measuring range 15m or 30m; evt. further menue presettings.

### Internal Heater <sup>(2)</sup>

<b>em100373</b>	680 Ohms	For power supply 230V 50-60Hz .....
<b>em100374</b>	220 Ohms	For power supply 115V 50-60Hz .....
<b>em100375</b>	8,2 Ohms	For power supply 20 .. 28V DC .....

### Weather protection cover

<b>zu400217</b>	.....
-----------------	-------

<sup>(1)</sup> Implements the electronic components needed to control the Internal Heater (needed for option pos.22)

<sup>(2)</sup> Used for replacement for already mounted heater.

In case of re-fitting the Internal Heater, the electronics must include components for the Internal Heater Control (please contact factory).

## Spare parts

---

### Sensor weights

All sensor weights are delivered including stated parts for proper fixing to the rope / tape

#### Rope version

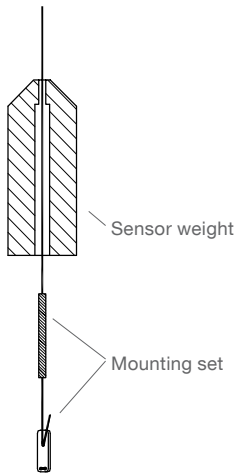

#### Tape version

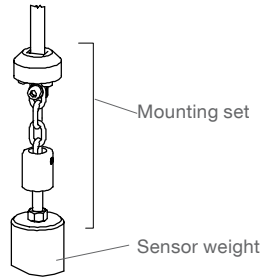

### Electronics

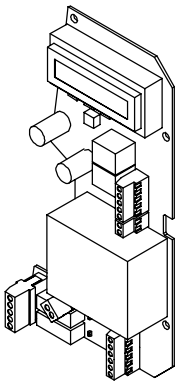

### Motor

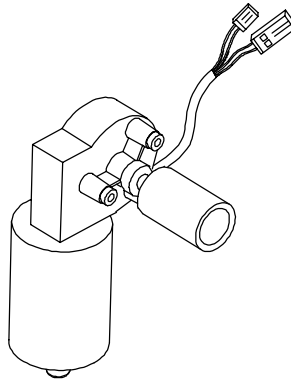

### Internal heater

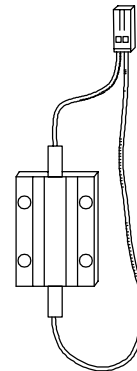

### Weather protection cover

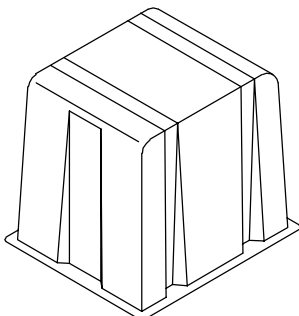

## Electrical installation

### Power supply

#### AC version

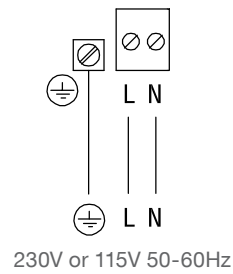

#### DC version

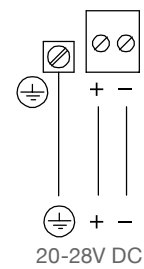

AC or DC supply  
depending on  
ordered version

### Signal input: Start of measurement

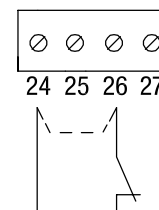
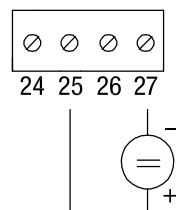
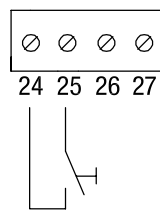

Start contact

Start +24V

alternative

Measurement interruption in  
case of filling. If used, remove  
factory provided connection.

### Signal output: 0/4-20mA

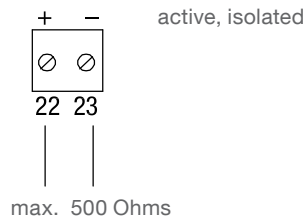

### Signal output: Relais (optional)

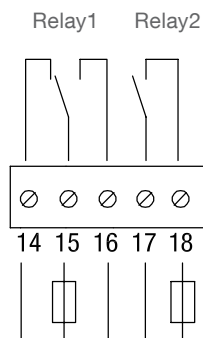

Fuse: max. 2A

max. 250V AC, 2A, 500VA, non inductive