

CONTENTS:

OVERVIEW

FEATURES

ADVANTAGES

SPECIFICATIONS

HYDRAULIC

MECHANICAL

ELECTRICAL

COMMUNICATION
PARAMETERS

STANDARDS

MECHANICAL INTERFACE

OVERVIEW

HydroSpin Monitoring Solutions Ltd. provides proprietary hydro generator systems that generate energy from the water flow within pipes to operate monitoring and control systems along the water distribution network.

HydroSpin 6" Yogev 10W hydro-power generator generates up to 10 Watt of power from the flow within water distribution pipes. The energy generated is suitable to support a wide range of applications such as flow and pressure instruments, 24/7 communication systems, dynamic pressure control systems, water quality analyzers, and data loggers.

HydroSpin 6" Yogev 10W is a standalone unit, easily integrated with any DN150 (6") pipe along the water distribution network, and designed for minimal head loss by implementing its proprietary swing mechanism.

When the flow increases, the generator rises above the flow line, to ensure minimal head loss. When the flow decreases, the generator swings back into the flow line to allow optimal energy harvesting.

Hydrospin Yogev 10W kit includes:

- Hydro-generator
- HydroCharger
- Internal rechargeable battery

FEATURES

- Patented wet generator and proprietary charging units
- Provides power 24/7 for monitoring and control instrumentations
- Suitable for drinking water distribution pipes
- Maximal power generation 10 Watt
- Minimal water head loss
- Standalone wafer unit, easily installed on any DN150 (6") pipe
- Includes proprietary swing mechanism for maintaining low head loss any time



ADVANTAGES

HydroSpin 6" Yogev 10W series enables 24/7 power availability to all monitoring and control systems, anywhere along the water distribution network.

HydroSpin 6" Yogev 10W Hydro Generator is a reliable power source replacing batteries, alternative power sources, and costly electrical connections, turning any water distribution network to a smart water network, through a simple and cost effective installation. HydroSpin 6" Yogev 10W supports:

- Dynamic pressure control systems
- Flow and Pressure instrumentations
- Communication systems
- Water quality analyzers
- 24/7 data transmission
- Data Loggers

CONTACT US:

Hydrospin Monitoring
Solutions
8 Hazoran St.
Netanya, Israel

Tel: +972-74-7136666
Fax: +972-4-6709014

Email: info@h-spin.com
<http://www.h-spin.com>

CONTENTS:

OVERVIEW

FEATURES

ADVANTAGES

SPECIFICATIONS

HYDRAULIC

MECHANICAL

ELECTRICAL

COMMUNICATION
PARAMETERS

STANDARDS

MECHANICAL INTERFACE

SPECIFICATIONS

HYDRAULIC

Minimum water velocity	0.12 m/s
Maximum water velocity	4.5 m/s
Water quality	Drinking water

MECHANICAL

Plastic materials	Nylon 50% (NSF 61)
Pressure class	PN16
Fitting	ISO/BS Wafer
Environmental protection	IP68

ELECTRICAL

Generator outcome power	3 Phase AC (3-70VAC)
HydroCharger output volts	12/24 VDC
HydroCharger output watts	Up to 10 Watts (Vs flow)
Reverse flow	30% less power
Maximum external load	1000mA (@24VDC)
Operated temperature	-20°C – 70°C
Internal rechargeable battery	Li-Ion 5.3AH (8.2V)
Typical duration without charge	48 hr (100mA const.)
HydroCharger internal consumption	5mA

COMMUNICATION PARAMETERS

Communication port	RS232
Protocol	Modbus RTU
Port baud rate	9600 [8,n,1]
Digital outputs	RPM, Alarm
Data logger	RPM, Battery Voltage, Generator Power, External Load (mA)

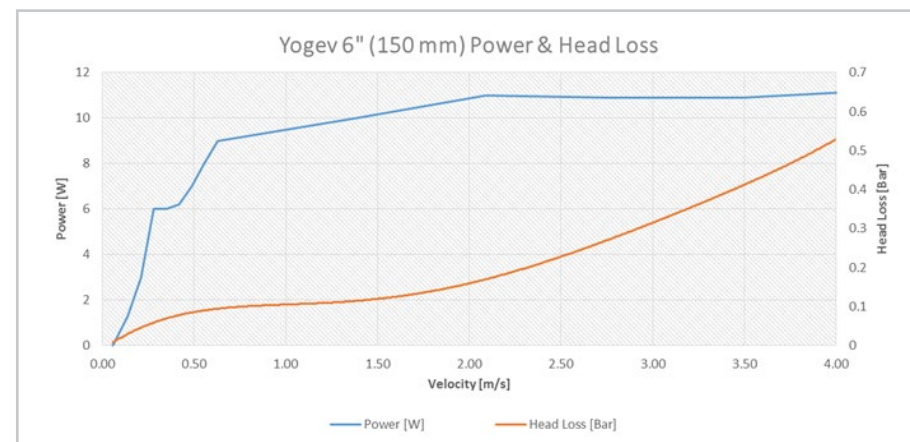
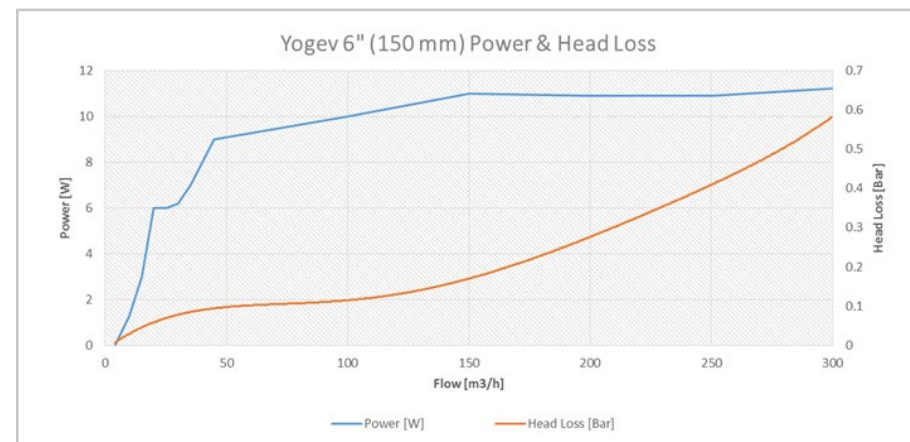

CONTACT US:

Hydrospin Monitoring
Solutions
8 Hazoran St.
Netanya, Israel

Tel: +972-74-713666
Fax: +972-4-6709014

Email: info@h-spin.com
<http://www.h-spin.com>

All specifications are subject to
change without notice
Updated: 10.02.16

This document contains confidential, proprietary information.

Document P/N : ??? | Rev A

CONTENTS:

OVERVIEW

FEATURES

ADVANTAGES

SPECIFICATIONS

HYDRAULIC

MECHANICAL

ELECTRICAL

COMMUNICATION
PARAMETERS

STANDARDS

MECHANICAL INTERFACE

MECHANICAL INTERFACE

Nominal size (mm)	150
I - Unit length (mm)	113
L - Total length between flanges (mm)	131
W - Width (mm)	222
H - Height (mm)	292
Weight (kg)	4

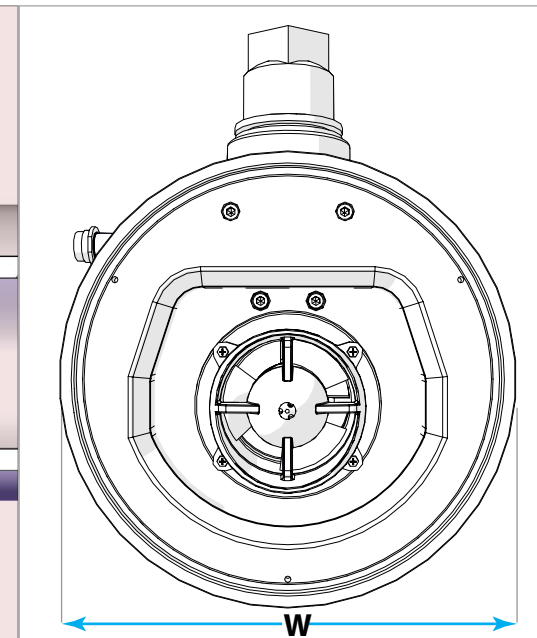
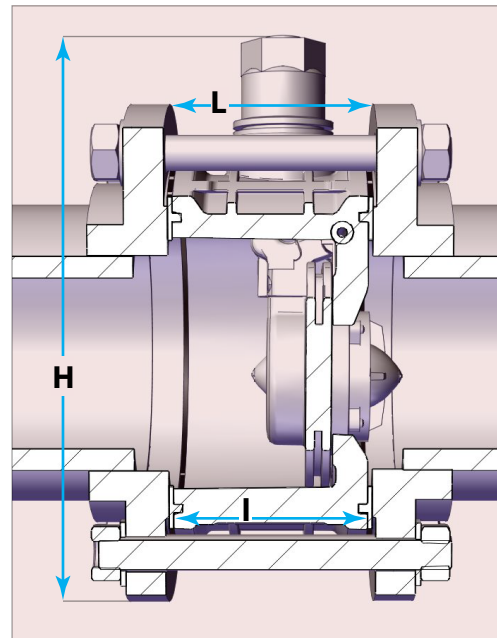
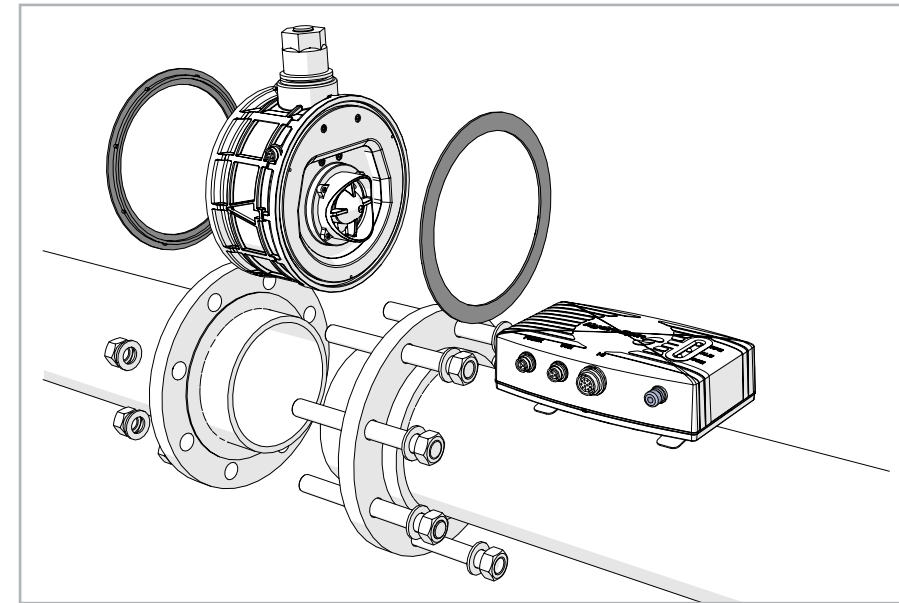

CONTACT US:

Hydrospin Monitoring
Solutions
8 Hazoran St.
Netanya, Israel

Tel: +972-74-7136666
Fax: +972-4-6709014

Email: info@h-spin.com
<http://www.h-spin.com>

All specifications are subject to
change without notice
Updated: 10.02.16